



Volume II

Appendix D.15

Maintenance, Material, and Management Inputs

Group I of the Columbia Accident Investigation Board was directed to examine maintenance procedures and sustainment issues as they related to the investigation, returning the Shuttle fleet to active service, and sustaining it for the foreseeable program lifespan. Specific areas of emphasis included: 1) Vehicle and subsystem analysis relating to the investigation, 2) Maintenance requirements determination including safety, quality assurance, scheduling and documentation, 3) Fleet sustainment issues including aging infrastructure and service life extension, and 4) logistics support issues including manpower, contract and financial management. This group's charter extended into management and sustainment issues and the final report includes proposed recommendations for the continuation of safe flight operations for the remaining Shuttles, *Discovery*, *Endeavour*, and *Atlantis*. The objectives of this report were to highlight, support, and present potential recommendations pertaining to key issues concerning the Shuttle fleet, its sustainment and support in the interest of preventing the next accident.

Various recommendations were made by the authors of this report and reviewed by the Board. Several were adopted into the final report. The conclusions drawn in the report do not necessarily reflect the conclusions of the Board; when there is a conflict, the information in Volume I of the Columbia Accident Investigation Board final report takes precedence.

Introduction

Section 1	Vehicle and Subsystem Analysis	423
1.1	Orbiter Wiring	423
1.2	Hypergolic Fuel Spill Documentation	427
1.3	Ov-102 Exposure to Elements/Increasing Corrosion	428
1.4	Premature Firing of Pyrotechnic Devices	430
1.5	SRB Bolt Catcher	431
1.6	Separation Bolt	434
1.7	Leading Edge Support System (LESS) Hardware Use	435
1.8	<i>Columbia</i> Hard Landing	436
Section 2	Maintenance Requirements Determination	436
2.1	Technical Data/Specifications	436
2.2	Safety and Mission Assurance	439
2.3	Maintenance Documentation (WAD Accuracy)	444
2.4	Capabilities Analysis	446
Section 3	Fleet Sustainment	448
3.1	Service Life Extension Program	448
3.2	Sustainment of Aging NASA Infrastructure	452
Section 4	Logistics Support	457
4.1	Workforce	457
4.2	Production Support	457
4.3	Shuttle Systems Depot Support	458
4.4	Budgets and Financial	459
4.5	Contracting Issues	459
4.6	SFOC Award Fee	462
4.7	Non-SFOC Contracts	464
4.8	Contractually Required Documents Applicable to External Tank Thermal Protection System (TPS) Foam Application	466
4.9	Contractual Penalties for External Tank Failure	467
4.10	Workforce: Size and Aging	467



Maintenance, Material, and Management Inputs

Submitted by Group I

Major General John L. Barry, Brigadier General Duane W. Deal, Rear Admiral Stephen A. Turcotte
Colonel Timothy D. Bair, John F. Lehman, Colonel David T. Nakayama

1.0 VEHICLE AND SUBSYSTEM ANALYSIS

1.1. ORBITER WIRING

Issue:

Proper inspection and maintenance of Kapton insulated wiring (MIL-W-81381) is an important factor as the Space Shuttle continues to age.

Background:

Kapton refers to a type of insulation (technical name: aromatic polyimide) developed by DuPont during the 1960s. It has many positive attributes: lightweight, less bulk/volume, excellent damage resistance, high dielectric strength, a wide operating temperature range, and inflammability (will not melt, drip, or propagate flame). Based on these attributes, it was widely used in the aviation industry in the 1970s through the 1990s, with applications in both military and civil aircraft, as well as the Space Shuttle. It has also revealed some disadvantages, the most notable being a breakdown of the insulation, leading to a phenomenon known as arc-tracking. Other disadvantages include “ringing” (circular cracks initiated by nicks in the Kapton) and hydrolytic degradation (moisture intrusion). Arc-tracking is the leading concern in the aviation community, though the level of concern and what actions should be taken vary widely, even among experts.

Findings:

Arc-tracking is the propagation of carbonization/insulation damage along the length of wire and to adjacent wires. When Kapton wiring experiences arc tracking, the insulation carbonizes at temperatures ranging from 1,100 to 1,200 degrees Fahrenheit. An important distinction must be made between carbonization and flammability. During tests (not related to the *Columbia* accident), Kapton wiring subjected to an open flame did not continue to burn when removed from the flame. However, carbonized Kapton becomes a

conductor, leading to what is referred to as a “soft short.” Systems with a “soft short,” as a result of carbonized wiring, do not necessarily drop off line in a clear, abrupt, or obvious manner, but may continue to operate in a degraded fashion. Figure 1.1.1 displays arc-tracking.

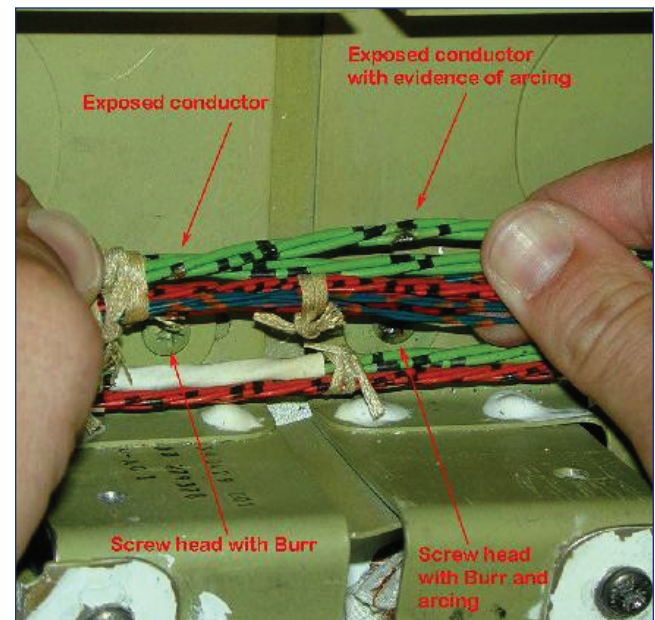

Figure 1.1.1. Picture of Kapton damage.

Kapton insulation breakdown manifests itself in the form of splitting, cracking, and flaking. The major causes of insulation breakdown are improper installation (at time of manufacture) and handling/mishandling during inspection and maintenance over the life of the vehicle. Examples of improper installation include routing wires with overly tight bends, clamping wires too tightly or with improper clamp insulation, and positioning wires against burred screw heads, rivet tails, or sharp edges. Subsequent to installation,

and over the life of the system, wiring stress is introduced through inspections and maintenance as technicians reposition wires, either to gain access to the wire bundle itself or to adjacent areas. Other disturbances contributing to insulation degradation include stepping on, laying equipment/tools on, or dropping tools on wiring. Conditions that degrade Kapton insulation, whether introduced during manufacture or during subsequent inspections and maintenance, are exacerbated by age of the vehicle and wiring, continued use (e.g., vibration), and environmental factors such as fluid spills and moisture intrusion.

Each Orbiter contains between 740,000 and 830,000 feet (140-157 miles) of wire. Over 570,000 feet of these totals are Kapton-insulated wire, with the remaining 169,000 feet being shielded wire with Kapton insulation. Over 1,700 feet of wiring is inaccessible without removing the crew compartment.

During STS-93 (*Columbia*, July 1999), a short-circuit five seconds after liftoff caused the loss of power to two of the six Main Engine Controller computers. This short circuit was later traced to a damaged wire in the left mid-body wire tray and prompted an examination of previous wiring problems. The results showed only two documented events related to arc-tracking in the Space Shuttle's history: a humidity separator wire on OV-099 during STS-6 in November 1982 and a teleprinter cable on OV-102 during STS-28 in July 1989. In efforts to identify and correct wiring problems, a partial inspection was initially conducted on all Orbiters during a fleet stand-down in 1999, with plans to perform more extensive inspections during Orbiter Major Modification (OMM) periods. OV-102 was the first to go through the more extensive wiring inspection during its J3 OMM at the Boeing facility in Palmdale, California (September 1999 – February 2001), shortly after STS-93.

Inspection of OV-102 during its J3 OMM provided the first "hard look" at Kapton wiring for any of the Orbiters. Areas not normally accessed during flow (down-mission, up-mission) processing were inspected. This extensive inspection revealed 4,884 wire anomalies: 1,890 were categorized as a "high level" nonconformances and reported under Problem Reporting procedures; of these, Kapton insulation accounted for 70 percent (1,324), or 27 percent of the total nonconformances. Finally, 2,123 were categorized as minor, or fair wear and tear. There was a strong correlation between the vehicle areas that experience the most personnel traffic during inspections and maintenance and wire damage.¹ The Boeing Inspection Report stated, "These findings demonstrate a real need for detailed wire inspection during modification periods, as it is doubtful that OMRS type inspections would have been as effective in detecting all of these anomalies."² Finally, redundant system wiring in the same bundles was separated to prevent damage from arc tracking propagation.

OV-103 is currently undergoing its J3 OMM (September 2002 – April 2004) at Kennedy Space Center. This OMM includes wiring inspections not conducted during the initial fleet stand down and, upon completion, OV-103 will be only the second Orbiter to have completed a full wiring inspection. As of the end of May 2003, the combined total of non-

conformances was 3,822 (1,677 during initial stand down inspection and 2,145 to date in OMM). The remaining Orbiters (OV-104 and OV-105) will complete their full wiring inspections in conjunction with their scheduled OMM completions (2004 for OV-105 and 2006 for OV-104, based on the recent decision to accelerate OV-105). A new and significant development presented at the 14 June 03 OMM Project Management Review (PMR) involved surprise/concern that the number of nonconformances on OV-103 is as high as on OV-102 and includes many in areas not previously regarded as susceptible, such as low traffic areas. This has led to a change from the earlier opinion of "Where there's traffic, there's wire damage" to "Where there's wire, there can be damage" and, in turn, concerns that delayed implementation of the wiring inspection and corrective action leads to an unquantifiable level of program risk. With OV-103 nearing completion of its OMM, and OV-105's accelerated OMM input, the only Orbiter in question is OV-104, based on its 2005 OMM input. As of publication, this situation continues to be evaluated by NASA with focus on what additional actions are necessary, and how soon must they be undertaken, to ensure continued safe operations.

Wiring nonconformances can be corrected several ways: re-routing, reclamping, or installation of additional insulation (convoluted tubing, insulating tape, insulating sheets, heat shrink sleeving, abrasion pads, and so forth). (See Figure 1.1.2) Additionally, testing of Orbiter wiring under normal operating loads has shown arc tracking in bundles usually stops due to wire separation (as opposed to circuit protection devices tripping). Further testing under conditions approximating the Shuttle wiring environment also showed that, after separation, arc tracking did not progress beyond six inches. Based on these results, Boeing recommended NASA separate all critical paths from larger wire bundles and individually protect them. This protection should extend a minimum of six inches beyond the confluence of critical paths.³ This is being implemented during OMMs.

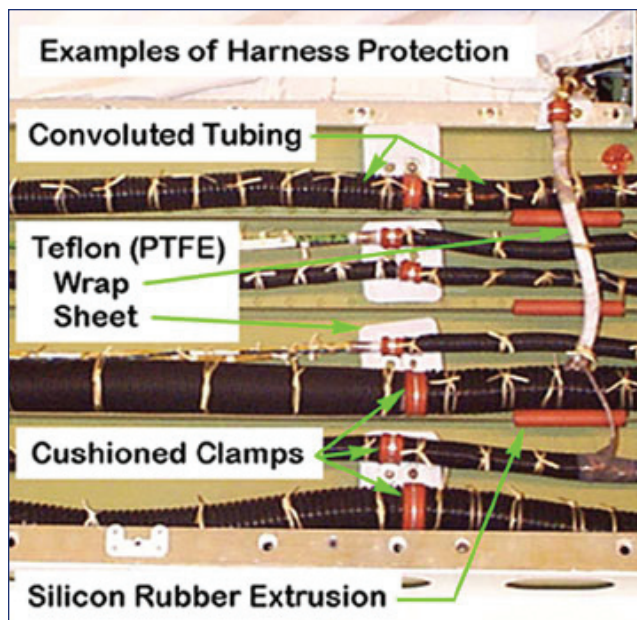

Figure 1.1.2. Examples of Harness Protection.

There have been a number of initiatives, over and above the inspections during OMM, directed at eliminating Kapton related problems. Databases used to record and trend nonconformances have been revised to allow for more precise reporting, to include the specific nature and location. Training to enable technicians and inspectors to better identify wiring nonconformances has been created with initial and recurring (every two years) requirements. Additionally, there is mandatory “Wiring Awareness” training for all personnel working on the Orbiter (not just electrical technicians) with a two-year recurring refresher. This training includes a video and is tailored to individual sections of the Orbiter: Cert 800 for forward and mid-body access, and Cert 801 for aft access. Another measure requires recurring wiring inspections whenever work is performed in an area; the type of inspection (Type 1 involves opening a wire bundle and “fanning out” the individual wires for inspection, Type 2 requires an area inspection without intruding into the bundle) depends on the type of work performed. Yet another measure requires technicians working on the Orbiter to tether their tools to avoid damage, should they inadvertently drop them. Finally, wire crimpers are now calibrated and controlled as calibrated devices, and work authorization documents stipulate specific crimping values and require technician documentation ascertaining compliance.

Inadequate inspection and maintenance practices have been recognized as contributing to Kapton-related problems in the military and commercial aviation communities. There has been increased recognition that wiring is not something to “install and forget about,” but must be treated as a “system” that requires ongoing inspection and maintenance. Similar actions are being implemented to varying degrees in the Space Shuttle Program. While new types of composite/hybrid insulations have recently replaced Kapton as the wire of choice in “new builds,” there are no plans for wholesale removal and replacement of Kapton wiring in existing inventories in the aviation community, though specific problem areas have been replaced. Since 1989, the Air Force has discouraged the use of Kapton by requiring System Program Office approval; the Air Force reviewed/revalidated this position in 1998. The Navy has followed a similar practice since 1985. Air Force Research Lab wiring experts (Wright-Patterson Air Force Base) have participated in a number of joint studies on Kapton with NASA and have provided inputs to the Shuttle Independent Assessment Team (SIAT) and played a role in expanding wiring inspections during OMM.

Care must be exercised in drawing parallels between the aviation community and the Space Shuttle Program. Many of the new composite insulations commercially available have been tested as potential replacements for Shuttle wiring, and no viable/improved alternatives to Kapton have been found. Two examples: TKT, a Teflon/Kapton/Teflon composite, lacks the robustness of Kapton; XL-ETFE, or cross-linked Tefzel, also lacks the robustness of Kapton as well as increased weight and a smaller temperature operating range. As with the years following Kapton introduction, it is still too early to know if the new insulations have any, as yet undetermined disadvantages, though one area of increasing criticism is their tendency to “scuff.” Finally, the Shuttle spends much less time, compared with military and civil aircraft, exposed

to the weather. Most of its ground time is spent in the controlled environment of the Orbiter Processing Facility.

As a whole, the aviation community has not been able to develop better test equipment to detect degradation of wiring prior to failure. Efforts in this area continue, with one being led by the Air Force Research Lab with participation and funding from NASA.

The Shuttle’s operating environment is the basis of two unique concerns: exposure of wiring to atomic oxygen (AO) and ultra-violet (UV) radiation. During a mission, the Orbiter’s payload bay doors are opened to expose cooling radiators. AO acts as an oxidizing agent and can lead to mass loss and surface property changes as a result of both chemical reactions and physical erosion. While laboratory tests have shown significant degradation due to AO, actual exposure has been significantly less than lab conditions and inspections have shown that degradation is minimal. UV radiation is known to enhance the degradation of organic insulations. Laboratory tests with Kapton have confirmed the incidence of delamination, shrinkage, and wrinkling.

There were wiring variations between the first Orbiter (OV-102) and subsequent vehicles. The wiring routed through the wing cavities outboard of the main landing gear wheel well wall of OV-102 were gathered in four bundles, while the wiring in other Orbiters was secured in seven bundles. (See Figure 1.1.3) This variation resulted from design changes to the wire bundle securing method. Clamps were used on OV-102, and metalized tape (MBO 135-050) straps were used on the remaining vehicles. Although effective, metalized tape is incapable of securing a bundle containing a large quantity of wires as configured in OV-102, hence the increased number of smaller bundles in subsequent Orbiters. Nearly 90 percent of wires routed through OV-102’s left wing forward of the main landing gear belonged either to systems gathering thermal, strain load, acoustic and other data for the Orbiter Experiment (OEX) instrumentation package (similar to the Modular Auxiliary Data System – MADS – on other Orbiters) or to disconnected systems. OEX data was recorded on magnetic tape that was downloaded after landing and not relayed via telemetry. The typical wire harness routing passes within 8-10 inches of the forward wing spar at the forward corner pass-through, immediately aft of the Reinforced Carbon-Carbon (RCC) panel 6. All temperature sensors in the main landing gear well were located within a four-foot radius with the main landing gear retracted. Fifty percent of all electrical drawings for the Orbiter fleet were unique to OV-102, due to first-production unit anomalies/changes, and additional wiring for the Developmental Flight Instrumentation (DFI, later OEX).

Analysis of telemetered data from 14 of *Columbia*’s left wing sensors (hydraulic line/wing skin/wheel temperatures, tire pressure, and landing gear downlock position indication) in the final minutes prior to the Orbiter’s breakup provided failure signatures supporting the leading causal scenario of left wing thermal intrusion, as opposed to a catastrophic failure (extensive arc tracking) of Kapton wiring. Actual NASA testing in the months following the *Columbia* tragedy, during which wiring bundles were subjected to intense heat (hot

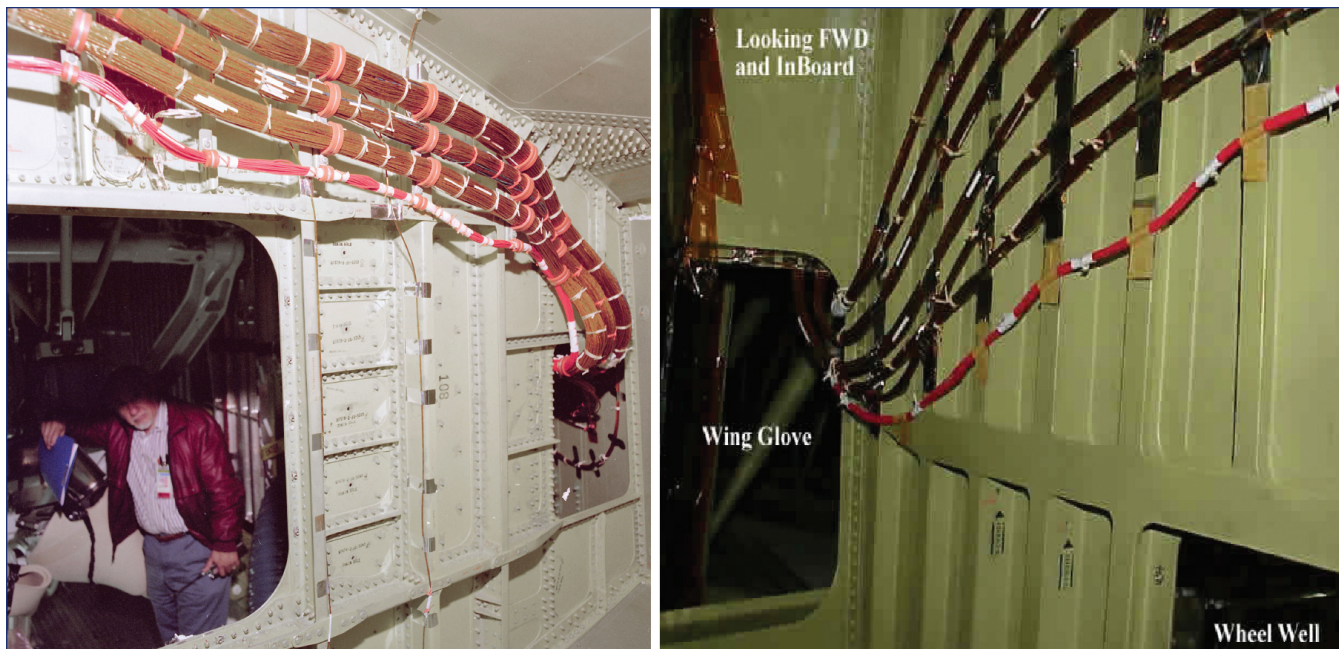

Figure 1.1.3. Wire Bundle Comparison.

oven, blowtorch, and arc jet), verified these failure signature analyses. Finally, extensive testing and analysis for years prior to STS-107 showed that, given the low voltages and low currents associated with the Orbiter's instrumentation system (such as those in the left wing), the probability of arc tracking is commensurately low.

Based on the extensive wiring inspections, pre-STs-107 maintenance and modifications, analysis of sensor/wiring failure signatures, and the lack of alignment of catastrophic wiring failure with any of the likely failure modes, the presence of Kapton wiring in *Columbia* is highly unlikely to be causal.

Still of concern is the 0.2 percent of inaccessible wiring (over 1,700 feet) which NASA has no plans to inspect, based on the absence of any Criticality 1 wiring. While the absence of "Crit 1" wiring reduces concern over the necessity of immediate inspection, based on findings during OV-103's OMM (that all wiring, including low traffic areas is susceptible to damage), and on projections to operate the Space Shuttle until 2020 (a service life approaching 40 years), this position needs to be reevaluated.

Proposed Recommendations:

NASA must make every effort to fully inspect every Orbiter in the fleet for wiring anomalies as soon as possible and incorporate arc-tracking redundancy separation.

Based on wiring inspection findings during OV-103's OMM, and on projected Space Shuttle operations until 2020, NASA should develop a plan to inspect the over 1,700 feet of inaccessible Orbiter wiring.

While NASA's actions to address wiring issues are highly

commendable, they **MUST** continue to treat wiring as a "system," collecting and analyzing data as the Orbiters age and this system evolves. This includes:

Assessing the effectiveness of all of the actions taken to date to minimize wiring problems.

Continuing to assess the impact of unknowns, such as AO and UV exposure as the Orbiter ages.

Assessing the cumulative effects of aging, to include moisture intrusion.

References:

1. USA briefing, "OV-103 J3 OMDP Project Management Review," 12 June 2003
2. NASA JSC Energy Systems Division (JSC/EP5) Test Report, "Cable Bundle Testing in the Arc Jet For the STS-107 *Columbia* Investigation," 6 June 2003
3. USA Orbiter Operations Requirements (Matthew Warren) e-mail, 30 May 2003, with attachments (MCR 23167, MCR 19596, MCR 19527)
4. USA briefing, "OV-103 J3 OMDP Project Management Review," 1 May 2003
5. NASA/JSC/EP briefing, "STS-107 Aero-Thermal/Cable Testing to Support Failure Scenario Team," 27 Mar 2003
6. NASA/JSC/EP briefing, "Brad's test results on single cable with voltage applied," undated but estimated around March 2003
7. Vehicle Data Mapping Team Report VDM-P10, "Sensor Signal Characterization For Failure Scenarios," 28 February 2003
8. NASA/JSC/EP briefing, "VDM Team Testing to Un-

- derstand Sensor Failure Modes,” 27 February 2003
9. Lockheed Martin Space Operations/Energy Systems Department report, “Preliminary Summary of the STS-107 Wire Bundle Burn Through Characterization Testing,” Contract NAS 9-19100, 18 February 2003
 10. NASA Vehicle Data Mapping Team briefing, Gene Grush, 15 February 03
 11. Report, “Wire Insulation Deterioration Analysis System Survey for Boeing Reusable Space Systems - Revised NASA Orbiter Sampling Test Results and Analysis,” Lectromechanical Design Company, 14 November 2001
 12. Boeing briefing, “Orbiter Avionics Damage Database Issues,” November 2001
 13. Paper, “Aircraft Wiring System Integrity Initiatives – A Government and Industry Partnership,” George Slenski and Joseph Kuzniar, Oct 2001
 14. Boeing report, “OV-102 Wire Inspection Report, September 1999 – February 2001,” July 2001
 15. “Summary Report on the Orbiter Kapton Insulated Wire Arc Track Investigation,” Lectromechanical Design Company, 16 July 2001
 16. Boeing briefing, “Arc Track Separation of Critical Wiring Redundancy Violations,” Joe Daileda, Jr., and Bill Crawford, 18 April 2001
 17. Boeing report, “OV-102 J3 V30/V31 Inspection Report,” March 2001
 18. Boeing briefing, “Wire Inspection Requirements for Future OMMs,” J. Daileda, 19 March 2001
 19. USAF/AFRL/MLSA briefing, “Aircraft Wiring System Integrity Initiatives,” George Slenski, 1 March 2001
 20. Boeing Workmanship Manual, “Flown and Used Orbiter Wiring Conditions,” 5 September 00
 21. Boeing briefing, “Orbiter Kapton Insulated Wire Age Test Results,” Joe Daileda, Jr., 27 June 2000
 22. Boeing briefing, “New Wire Insulation Study For Potential Orbiter Use,” Joe Daileda, Jr., 5 June 2000
 23. Boeing Training Course Presentation, “Orbiter Wiring Discrepancy & Repair,” April 2000
 24. NASA report, “Space Shuttle Independent Assessment Team,” 7 March 2000
 25. Briefing, “Space Shuttle Independent Assessment Team Sub-Team on Wiring,” George Slenski, 8 November 1999
 26. USA briefing, “Fleet Wire Inspection & Repair Summary,” Doug White, 2 November 1999
 27. Paper, “Managing Electrical Connection Systems and Wire Integrity on Legacy Aerospace Vehicles,” Steven J. Sullivan (NASA/KSCARRIER PANELK-F) and George Slenski (USAF/AFMC/AFRL/MLSA), September 1999
 28. Testimony of Bernard Loeb, Director Office of Aviation Safety, National Transportation Safety Board, on “Aging Aircraft Wiring” before the Subcommittee on Oversight, Investigations, and Emergency Management Committee on Transportation and Infrastructure, House of Representatives, 15 September 1999
 29. “Electronic Failure Analysis Handbook, Chapter 15: Wires and Cables,” George Slenski, 1999
 30. Final Report, “Study and Recommend New Wire Insulation Task,” Gary Troeger, undated (est. 1998)
 31. International Conference for the Promotion of Advanced Fire Resistant Aircraft Interior Materials paper, “Development and Analysis of Insulating Constructions for Aerospace Wiring Applications,” George A. Slenski, 10 February 1993
 32. NASA Conference Publication 10145, “First NASA Workshop on Wiring for Space Applications,” 23-24 July 1991
 33. Lewis Research Center Space Application Wiring Workshop briefing, “Orbiter Kapton Wire Operational Requirements and Experience,” R.V. Peterson (Rockwell International), 23 July 1991
 34. Air Force Wright Aeronautical Laboratory briefing, “Understanding Flashover – Wet Arc Tracking Material Properties Arc Propagation,” 1 September 1987
 35. Article, “Pyrolytic Polyimide Is Semiconductor,” C&EN, 26 July 1965

1.2 HYPERGOLIC FUEL SPILL DOCUMENTATION

Issue:

Spill of hypergolic fuel on OV-102 during maintenance could have damaged Orbiter Thermal Protection System (TPS) and/or structure.

Background:

OV-102 experienced a hypergolic fuel spill on August 20, 1999 at KSC during preparation for shipment to Palmdale. A maintenance technician had disconnected a hydrazine line without capping off the line, and laid it down on a maintenance platform, enabling 2.25 ounces of the volatile and corrosive fuel to drip onto the trailing edge of the left inboard elevon. After the spill was cleaned up, two tiles were removed for inspection, with no damage found to the control surface skin or structure. The tiles were replaced, with no further maintenance action taken.⁴

Engineers from United Space Alliance (USA) briefed the Shuttle Operations Advisory Group on November 1, 1999 of the corrective action taken, which consisted of briefing all USA employees working with these systems on procedures to prevent recurrence. All briefing recipients signed and stamped off a roster acknowledging receipt of the briefing. Improvements to the ground support equipment were recommended. Plan also included permanent installation of the de-servicing panel, interconnects, and flexible hoses.

Findings:

The subject event was investigated and corrective actions were implemented by the Shuttle Operations Assessment Group (SOAG) and are tracked in the Safety Reporting Database as SOAG 99-069. This event was closed in the database on 2-9-01: “Expedite implementation of Engineering Support Request ESR K16460 for installation of permanent APU panels in Orbiter Processing Facilities (OPF) 1, 2 and 3 that will eliminate use of temporary Ground Support Equipment for major hazardous propellant transfer operations.”⁵ Engineering Support Request (ESR) K16460 was implemented to install permanent APU panels in OPF 1, 2, and 3

that will eliminate use of temporary GSE for major hazardous propellant transfer operations. In checking the status of the completion of ESR K16460 with the Program Office Configuration Control group, investigators found that the ESR has not been completely closed. It appears that the work in all three OPFs has been completed and changes made to the engineering. The ESR is being held open until the engineering is changed to agree with the as-installed configuration. There is also one Problem Report (PR) open pending engineering on work to be done in-house that must be completed before the ESR is finally closed. There is no expected completion date for these details.

There is no reason to believe the actions taken were anything less than adequate. The hypergolic spill is not believed to have been a factor in the accident. The spill is believed to have had no effect on the wiring, the TPS, or the underlying structure.

Proposed Recommendations:

None. Immediate corrective action taken was appropriate given the small quantity of fuel spilled. Follow-on permanent corrective actions implemented by USA are adequate and in place.

1.3 OV-102 Exposure to Elements/Increasing Corrosion

Issue:

Review/assess Orbiter exposure to environmental elements, including OV-102. Determine what actions are necessary, if any.

Background:

OV-102 had a cumulative launch pad exposure of approximately 3.3 years, and the fleet of four Orbiters had a total of 11.8 years at the time of *Columbia*'s loss. Exposure anywhere, but especially in the highly corrosive environment at Kennedy Space Center (KSC), has a negative impact due to corrosion/oxidation/damage/deterioration of materials such as structure, wiring, and insulation. This is a significant concern, given the fleet's age of nearly 20 years and the possibility of continued service for another 20 years.

Findings:

Individual Orbiter exposure time (excluding OV-102) varies

from 2.1 to 2.9 years. OV-102 led the fleet in total exposure time at 3.3 years. When exposure time is averaged over the number of launches, OV-102, with 28, averages 43.1 days per launch. OV-103 (Discovery), with 30 launches, averages 35.0 days. There is nearly a seven-day difference between OV-102's average and that of the rest of the fleet. See Figure 1.3.1 for a comparison by Orbiter.

Exposure is measured from the time an Orbiter rolls-out of the Vehicle Assembly Building (VAB) until it is either launched or rolled-back to the VAB. Other events, notably ferry flights and stays at Edwards Air Force Base, also count toward exposure. Exposure time is due to a number of factors: normal launch preparations, including servicing; troubleshooting and repairing maintenance problems; deservicing prior to rollback to the VAB, whether for hurricane "safe havening" or for maintenance; and pad functional checks. OV-102 holds the record for the longest exposure associated with a launch: 164 days for STS-35; OV-103 holds the record for shortest exposure: eight days for STS-96.

The 164-day exposure for STS-35 occurred over eight months and four launch attempts, from April to December 1990, and illustrates the complexities associated with launching Shuttles. OV-102's initial rollout was on April 22; a Freon system repair added 14 days, but the launch was scrubbed on May 30 due to a Main Propulsion System (MPS) liquid hydrogen (LH2) leak. After troubleshooting and maintenance preparations, OV-102 was rolled back to the VAB on June 12. It was rolled out a second time on August 9, but required a 6-day stand down for telemetry repair. Its September 1 launch was scrubbed on 5 September due to another hydrogen leak. Following maintenance at the pad, the next launch attempt was scrubbed on September 18, due to another MPS LH2 leak. After further troubleshooting and maintenance preps, it was rolled back on October 9. Rollout next occurred on October 14, followed by special LH2 tanking tests for two additional days; however, Auxiliary Power Unit water valve problems and follow-on maintenance and servicing took another 16 days. OV-102 finally launched successfully on December 2. It should be noted that STS-35 is an outlier when compared with all other Shuttle launches. Figure 1.3.2 shows a comparison of exposure time by mission.

Besides pad exposure, an Orbiter's most notable vulnerability to environmental exposure is during mate/demate and ferry operations. Three events were noted, all related to mate/demate/ferry ops, in which Orbiters accumulated significant rainwater internally; two involved OV-102. In September 1999, as OV-102 was being mated to the 747 Shuttle Carrier

	Challenger	Endeavour	Atlantis	Discovery	Columbia	Total Fleet	Fleet minus Columbia
Total Days Exposed	361	749	948	1,050	1,208	4,316	3,108
# of Launches	10	19	26	30	28	113	85
Avg. Days per Launch	36.1	39.4	36.5	35.0	43.1	38.2	36.6

Figure 1.3.1. Orbiter Environmental Exposure at Launch Complex 39.

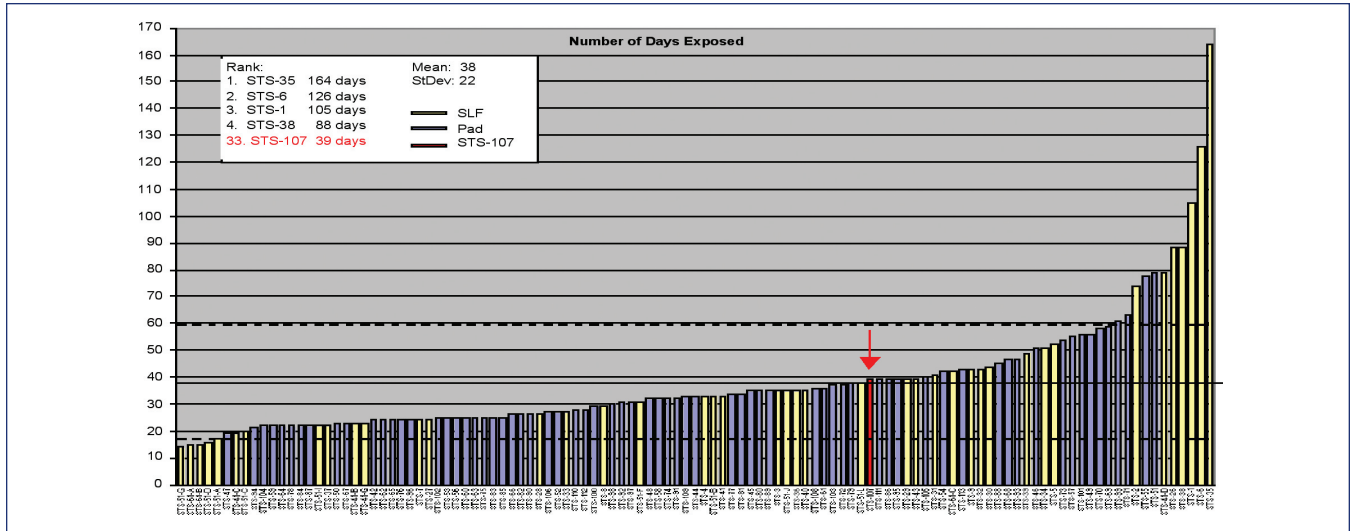

Figure 1.3.2. Exposure by Mission: red arrow depicts STS-107, STS-35 is at far right.

Aircraft (SCA) for a ferry flight to Palmdale, California, it was caught in the rain; 128 pounds/16 gallons of water were removed after its arrival at Palmdale. In February 01, after OV-102 had been mated to the SCA for its return from Palmdale to KSC, it was again caught in a downpour. The mated Orbiter/SCA were partially sheltered in a hangar but, due to



Figure 1.3.4. An Orbiter and SCA partially inside a hangar in Palmdale.

vertical clearance limits, the tails of both craft remained exposed (See Figure 1.3.4). After arrival at KSC, 112 pounds/14 gallons of water were removed. The same February 2001 rainstorm at Palmdale also affected OV-104, which had recently landed (February 20/STS-98) and was being prepared for its ferry flight to KSC. OV-104's "aft fuselage under bay 6 [was] full of standing water" and water was "five inches deep along [the] back of 1307 bulkhead;" 1,600 pounds (200 gallons) were removed after its arrival at KSC.

Environmental exposure constraints are clearly outlined in RTOMI S0018.100, Adverse Environmental and Lightning Monitoring at LC39. This publication includes guidance on actions to minimize exposure to rain, hail, winds, freezing temperatures, or tornados. In spite of this existing guidance, circumstances such as those related above, both on the launch pad and during ferry operations, contribute to more exposure than is desirable. Figure 1.3.5 shows rain exposure data by launch, with STS-35 again being the worst case.

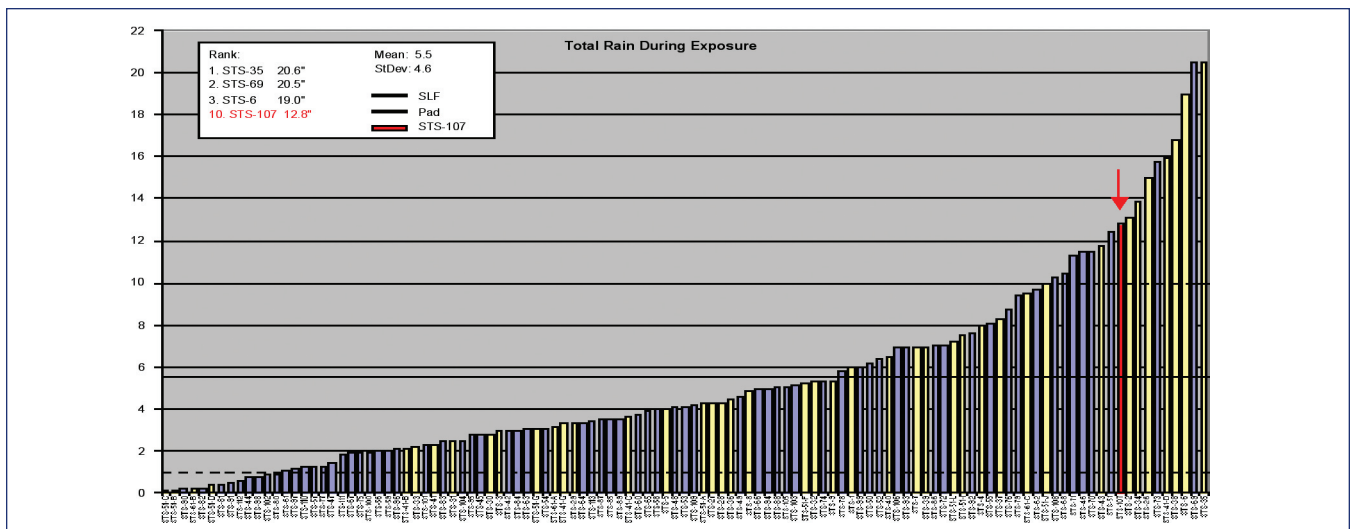

Figure 1.3.5. Total rain exposure by launch (arrow denotes STS-107; STS-35 at far right).

The environment at KSC is about as challenging, from a corrosion perspective, as exists. The necessity to control exposure is reflected in the amount of work needed to keep the Orbiters in a mission-ready condition. Corrosion, in general, is trending upward for the Orbiter fleet by 10 percent annually, and there is a marked increase in corrosion in areas such as the body flap cove (one of the lowest points when the Orbiter is in a vertical orientation). Figures 1.3.6 and 1.3.7 show these corrosion increases, one classic symptom of aging aircraft.

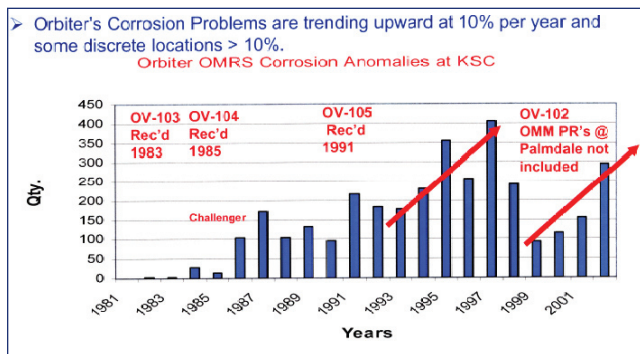

Figure 1.3.6. Increasing orbiter corrosion trends.

While corrosion is symptomatic of normal aging, in the Orbiter's case, its location at the aft (lowest point in its launch configuration) shows the effect of launch pad exposure. The body flap cove and surrounding area, as well as associated hardware, are showing significant growth in man-hour consumption to grind out corrosion pits. Components, such as the body flap actuator, illustrate the increasing challenge posed by corrosion and the impact on logistics and spare parts availability. Over the last several years, body flap actuators have been removed for corrosion. During repair, internal corrosion has also been discovered, with some piece parts being beyond repair. Manufacturing new piece parts entails extensive lead times, in some cases years. Status of body flap actuators at the end of April 2003 was seven in inventory, with four installed; two had been removed and were in the repair cycle, along with the only spare; the first serviceable spare was projected to be available in June 2003.

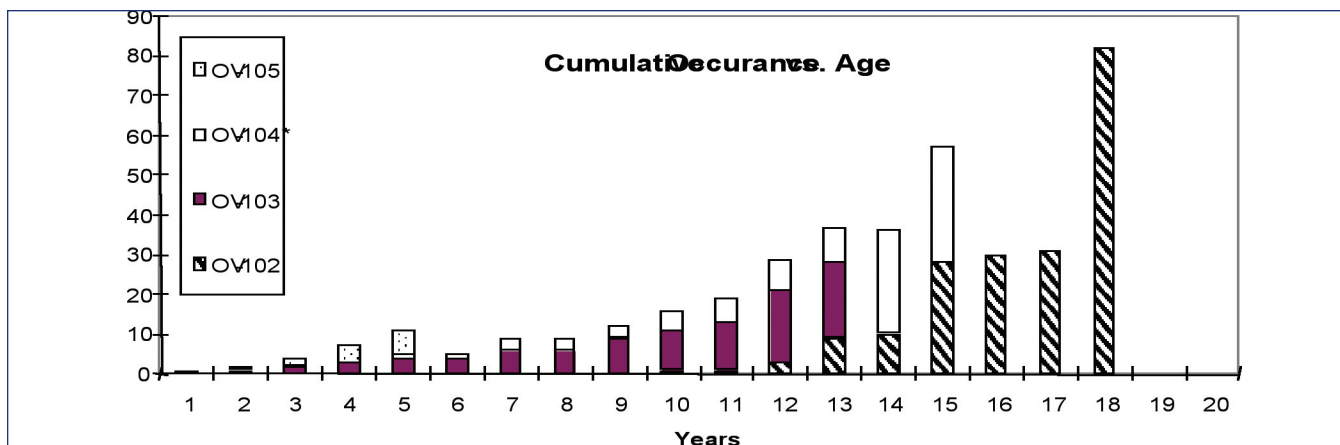

Figure 1.3.7. Fleet corrosion in body flap cove area.

Proposed Recommendations:

Corrosion is a problem in both military and commercial aviation. Due to the Shuttle's critical mission and limited design life (originally projected to be between 10 and 20 years), as well as its now projected use for as much as another 20 years, strict adherence to existing guidance must be reemphasized on an ongoing basis. Furthermore, every opportunity to avoid/minimize/reduce exposure must be taken. Ground Operations should review launches where exposure was more than one standard deviation above or below the mean (Figure 1.3.5.) for lessons that may be applied to reduce exposure. Finally, as some amount of exposure is unavoidable, the Space Shuttle Program must have an intensive corrosion program of inspection, treatment, and prevention. Such a program will factor into the fledgling Service Life Extension Program.

References:

1. Applied Meteorology Unit Memorandum, "Analysis of Rain Measurements in Support of the STS-107 Investigation," Dr. Francis Merceret, April 2003, with attachments
2. KSC Weather Office (John Madura) e-mail, "Orbiter Pad Exposure Days," 4 April 2003, with attachments
3. Boeing/Palmdale Director of Assembly and Test Operations (Al Hoffman) e-mail, "Water Damage On Board Columbia – Palmdale," 26 March 2003, with attachments
4. 45th Weather Squadron/Shuttle Launch Weather Office memo, "Shuttle Ops Weather Constraints," Katharine Winters, July 2002
5. NASA/JSC/Orbiter Engineering Office meeting minutes of Orbiter Structures Telecon, 19 June 2001

1.4 PREMATURE FIRING OF PYROTECHNIC DEVICES

Action/Issue:

Determine the temperature necessary for auto-ignition of the pyrotechnic devices in the main landing gear wheel well and their possible role in the loss of *Columbia*.

Background:

The only pyrotechnic device in the main landing gear well is the gear uplock release thruster pressure cartridge. This cartridge, when activated by a NASA Standard Initiator (NSI), produces a pressure output that activates the main gear uplock thruster to lower the main landing gear. In the event of hydraulic system failure, a fire command is sent to the NSI/cartridge one second after the gear deployment command if there is no gear movement, as detected by a proximity sensor.

Findings:

There are 137 NSIs used to activate cartridges throughout the shuttle: 102 are fired during a nominal mission and 35 are for emergency applications, including main landing gear extension. The cartridges on STS-107 were from lot HTN, manufactured and accepted in 1994 based on successful acceptance testing.

Qualification requirements for cartridges specify an operating temperature range of -80 to 350 degrees Fahrenheit and no ignition when thermally soaked at 425 degrees for one hour. Tests on February 1, 2003, using cartridges from lot HTE, subjected units to external heating at a rate of 25 to 35 degrees per minute, with ignition occurring at 598 degrees Fahrenheit.

NASA engineers believe actual auto-ignition of these cartridges would require a temperature far exceeding 598 degrees Fahrenheit, based on insulation/shielding in their installed configuration. The actual temperature would be difficult to determine, as tests in an installed configuration have not been conducted. However, the condition of the recovered left and right landing gear and associated components does not support a premature landing gear deployment scenario.

Conclusions:

Auto ignition of pyrotechnic cartridges will not occur below 598 degrees Fahrenheit; however, exactly what temperature this will occur at is unknown and difficult to determine. The condition of recovered main landing gear debris and associated components does not support premature main landing gear deployment.

Proposed Recommendations:

None. Any failure scenario cannot exclude pyrotechnic auto ignition as a factor.

1.5 SRB BOLT CATCHER

Issue:

The Solid Rocket Booster (SRB) forward attachment separation bolt catcher was considered as a potential cause of damage to the Orbiter during SRB separation.

Background:

The External Tank (ET) is attached to the SRB Forward Skirt with one pyrotechnic separation bolt. At SRB separation, this bolt is pyrotechnically separated into two halves. On the ET side of the interface, a "bolt catcher" (see Figure 1.5.1) is mounted to catch the upper half of the fired separation bolt following NASA Standard Initiator (NSI) firing. The bolt catcher consists of a domed aluminum cover containing an aluminum honeycomb matrix to deform and absorb the bolt's energy as it is "caught." The bolt catcher is designed to prevent liberated objects from hitting the Orbiter after firing.

Early in the investigation process a fault tree of potential causes was developed that included the SRB and the bolt catcher system as a potential causal factor in the accident. In an effort to eliminate the bolt catcher a records review revealed some confusion regarding which two serial controlled catcher units were used in the STS-107 stack: 1, 19, or 41. There was a discrepancy between the USA and the Michoud Assembly Facility (MAF) serial numbers on the bolt catchers used on STS-107. During buildup of a Shuttle ET, the bolt catchers (two manufacturers, Summa and Harris) are furnished by USA and each is stamped with a USA serial number. When the unit is prepared for shipment with the ET, the old (USA) number is chemically removed, and then the catcher is coated with super lightweight ablative (SLA) material. At this point, the MAF assigns each bolt catcher a new serial number. Apparently the paperwork documenting which two Summa bolt catchers were used was unclear and does not positively identify which original USA numbered unit was used. MSFC system officials believe they have eliminated number 41 leaving numbers 1 and 19 as the Summa catchers used on STS-107. Harris bolt catchers have never been used on a Space Shuttle mission. The stated reason is that the Summa catchers are older and NASA/USA is using them up first.

Findings:

The configuration of the current bolt catcher flight hardware differs significantly from the original qualification test configuration.⁶ First, the attachment of the bolt catcher used in the original test fixture was qualified using through-bolts into a metal that was dissimilar to the ET/SRB attach point. The mounting method used for flight hardware (including STS-107) is bolts threaded into inserts. Second, original catcher testing did not have the SLA applied. Third, the original design load expected during bolt separation was determined to be 29,800 pounds in the 1979 timeframe. During initial tests the bolt catcher failed at the weld. The reason for this failure was determined to be overly rigid honeycomb, which led to the redesign of the honeycomb to reduce its static pressure capability from 1400 to 1000 psi. Finally, during the original test, temperature and pressure data were not recorded for the bolt firing. Instead of conducting additional tests, the flight design configuration was accepted by analysis (of extrapolated test data and the redesign specifications) and similarity. Consequently, predictive failure analysis, in the absence of post-flight evidence for examination (the bolt catcher and upper half of the separation bolt remain with the external tank and are therefore lost on reentry), must also be

based on analysis of limited data from testing 24 years ago or a new round of testing in order to remove the bolt catcher from investigative consideration. The current bolt catcher design was certified on the basis of analysis and similarity after limited testing. A new round of testing is underway to support the investigation.

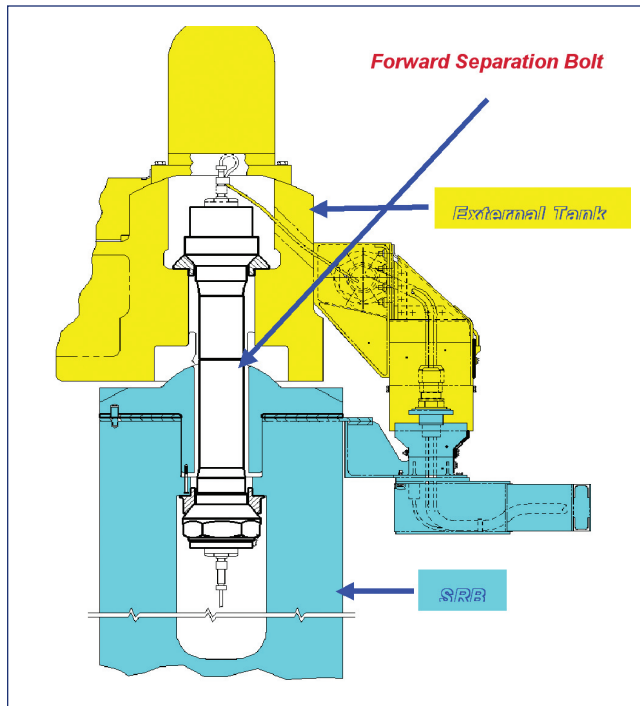

Figure 1.5.1. Diagram of a bolt catcher.

In the absence of physical evidence and adequate test data to measure bolt catcher performance against, it must be assumed that the bolt catcher could have played a role in damaging the left wing LESS of *Columbia*. Specifically, the dome could have catastrophically failed at the weld, SLA coating could have come off (in adequately large quantity to damage the shuttle), or a bolt/insert could have failed to hold. Review of radar imaging data reveals objects were liberated from the STS-107 stack at the time of SRB separation (approximately 126 seconds).⁷ Much of this debris is from known sources aft of the Orbiter, and do not present a threat to the vehicle. However, the radar data has been inconclusive, to date, as to whether the bolt catcher could have been a part of the separation debris. Several other methods will be used to investigate the bolt catcher's potential as a source of damage to the LESS Thermal Protection System on *Columbia*. First, review of existing, but limited, data from STS-107. Second, a new set of tests of the as-flown configuration is being performed to better characterize the bolt catcher performance parameters.

Radar tracking and imaging is routinely done for every Space Shuttle launch and follows the vehicle well beyond SRB separation. The Board requested that the radar data from STS-107 be reviewed to determine if any objects came off the vehicle around the time of SRB separation. One event, (called debris item #33) at approximately 126

seconds after launch, produced a radar return consistent with the radar cross section of a bolt catcher.⁸ The NASA team reviewing this data pulled the radar launch data from previous Shuttle missions to determine if this event was unusual. They discovered five previous missions with a similarly sized radar image liberated from the Shuttle stack at about the same time. Most missions have ascent pictures taken of the vehicle that show the (apparently) intact bolt catcher dome. Pictures of these same five missions showed all but one bolt catcher (STS-110) of the 10 intact and in place. The STS-107 pictures (taken from the ground) are indiscernible (see Figure 1.5.2). Video, taken by the STS-107 crew, of the ET as it floated away from the Orbiter does not show bolt catcher detail either. The review of MADS data did not show any off nominal events at the 126-second point (SRB separation) or immediately afterward as would be expected if a large enough item hit the wing. Consequently, there are no conclusive data points that would include or exclude the bolt catcher from consideration in this investigation.

Mission	LH Vehicle	RH Vehicle
STS-113	Not in FOV	Not in FOV
STS-112	Visible	Visible
STS-111	Visible	Visible
STS-110	Visible	Not in FOV
STS-109	Visible	Visible
STS-108	Dark Exposure	Dark Exposure
STS-106	Visible	Visible
STS-105	Visible	Visible
STS-104	Visible	Not in FOV
STS-103	Dark Exposure	Dark Exposure
STS-102	Not in FOV	Visible
STS-101	Visible	Visible
STS-100	Visible	Visible
STS-099	Visible	Visible
STS-098	No Film	No Film
STS-097	Poor Quality	Poor Quality
STS-096	Visible	Visible
STS-095	Visible	Visible
STS-093	Dark Exposure	Dark Exposure
STS-092	No Film	No Film
STS-091	Visible	Visible
STS-090	Visible	Visible
STS-088	Dark Exposure	Dark Exposure

FOV = Field of View
 "Visible" indicates that the bolt catcher was identifiable in its installed position in post-SRB separation photographs.

Figure 1.5.2. Ascent photography of bolt catchers.

Testing was conducted to baseline the bolt catcher performance in the “as-flown” configuration. Testing began on May 27 and was completed in June 2003. These tests were done using various parameters and configurations, consistent with the system’s history and current configuration. Intent of the tests is to “characterize loads with NSI ejection and nominal firing, qualification of SLA structural integrity, verify analytical models for safety factor determination, provide closure for the STS-107 accident fault tree and provide return to flight rationale.”⁹ Analysis of early results shows some interesting and somewhat alarming results. During the first three separation bolt tests the dynamic test peak loads were 22, 46, and 36 KIPs (thousand pounds), respectively. Those values were derived from strain gage measurements, and are believed to be accurate to approximately +/-10 percent. The peak load the bolt catcher was predicted to absorb during separation bolt firing was 29.8 KIPs. The lower number seen in the live fire separation bolt test was believed to be the result of a test-induced failure of one of the two bolt initiators. During the static tests (to date, 10 tests using a Harris and 1 using a Summa bolt catcher), load measurements at the point of catcher failure ranged from 44 - 59.7 KIPs. Those load measurements are direct readings from a load cell and accurate to + or - 2 percent. All of the bolt catchers failed well under the expected range of 68 KIPs and at the heat affected zone of the weld (instead of the expected failure of one of the mount bolts). The first test was designed to simulate the increased internal pressure (75 psid) seen when an NSI fires and is subsequently ejected from the bolt into the honeycomb ahead of the bolt half, as happened in about 20 percent of the missions. This test demonstrated that ejection of the NSI does not increase the load on the bolt catcher.

The first two Harris bolt catchers failed at an equivalent static load of 54 KIPs (+/- 2 percent), and 57 KIPs (+/- 2 percent), respectively. The third static test (using a Summa manufactured catcher) produced the most alarming results. This catcher failed at 44 KIPs (+/- 2 percent). The second dynamic test of a separation bolt firing produced a derived load on the bolt catcher of 46 KIPs (+/- 10 percent). If these results are consistent with the remaining tests, the factor of safety would be 0.956 for the bolt catcher and is significantly under the NASA design requirement of 1.4. The results of this test do not eliminate the bolt catcher from fault tree consideration and may imply a significant weakness in NASA’s method of certification of critical systems by analysis and similarity.

The substandard performance of the Summa catcher used in this test led the test officials at Marshall to review its historical records that remain with each catcher. Every bolt catcher must be inspected (via x-ray) as a final step in the manufacturing process to ensure specification compliance. There are specific requirements for film type/quality to allow sufficient visibility of weld quality (where the dome is mated to the mounting flange) and reveal any flaws. There is also a requirement to archive the film for several years after the hardware has been used. The manufacturer is required to evaluate the film and a Defense Contract Management Agency (DCMA) representative certifies that requirements have been met. The substandard performance of the Summa Bolt Catchers tested by NASA at MSFC and subsequent investigation revealed the contractor’s use of film failing to

meet quality requirements and, because of this questionable quality, “probable” weld defects in most of the archived film. Film of STS-107’s bolt catchers (serial numbers 1 and 19, both Summa manufactured), was also determined to be substandard with “probable” weld defects (cracks, porosity, lack of penetration) on number 1 (left SRB/ET attach point); number 19 appeared adequate, though the substandard film quality leaves some doubt.

Further investigation revealed a lack of qualified non-destructive inspection (NDI) technicians and differing interpretations of inspection requirements as contributing to this oversight. USA, NASA’s agent in procuring bolt catchers, exercises limited process oversight, delegating actual contract compliance verification to DCMA. DCMA interpreted its responsibility as limited to certifying compliance with the requirement for x-ray inspections. Since neither DCMA nor USA had a resident NDI specialist they could not read the x-ray film or certify the weld. Consequently, the required inspections of weld quality and end-item certification were not properly performed. Inadequate oversight and confusion over the requirement on the parts of NASA, USA, and DCMA all contributed to this problem.

The x-ray testing (done as final step in manufacture to certify it as flight ready) film was reviewed by NASA NDE technicians after the test and clearly shows substandard film quality and possible weld problems. These test results and the potential weld issues of the STS-107 bolt catchers lead to the conclusion that this system (in conjunction with a radar event at the 126 second point) may have contributed to the causal chain of events that lead up to the loss of *Columbia*.

Transport analysis of the possible trajectory of a liberated bolt catcher (with and without the bolt upper half) was initiated by the NASA led Working Scenario group. The results of this study show several paths for the catcher to have traveled based on seven different velocities at departure. In summary, the zero velocity departure path can be traced to a point approximately 161 inches forward of the leading edge of the left wing. This is considered to be within the margin of error considering the numerous factors that are required to perform transport analysis. Consequently, the bolt catcher cannot be eliminated from the fault tree as a potential source of the damage to *Columbia*’s leading edge.

In addition, STS-107 radar data from the Eastern Range tracking system identified an object departing the stack at the time of Solid Rocket Booster separation that had a radar cross-section consistent with a bolt catcher. The resolution of the radar return was not sufficient to definitively identify the object. However, an object that has about the same radar signature as a bolt catcher was seen on at least five other Shuttle missions. Debris shedding during SRB separation is not an unusual event. However, the size of this object could be a potential threat if it came close to the Orbiter after coming off the stack.

Though bolt catchers can be neither definitively excluded nor included as a potential cause of left wing damage in STS-107, the impact of such a large object would likely have registered on *Columbia*’s sensors, which measure forces on

the vehicle. The “out of family” but indefinite data at the time of Solid Rocket Booster separation, in tandem with overwhelming evidence related to the foam debris strike, lead the Board to conclude that bolt catchers are unlikely to have been involved in the *Columbia* accident.

Proposed Recommendations:

Radar cross-section analysis of the bolt catcher minus SLA has been done, but has been inconclusive when compared to radar imagery. NASA should redo this comparison with SLA if launch radar data accuracy is adequate to draw conclusions.

Remove all remaining Summa and Harris catchers from service until testing is complete (including x-ray evaluation of all welds). Attempt to determine the Factor Of Safety on the Summa bolt catcher and the likelihood that STS-107 experienced an in flight failure of the Summa bolt catchers. Complete design upgrades to the SRB Bolt Catcher and perform qualification testing to certify the new configuration for flight use.

The investigative review of this system has revealed a number of errors in the methodology used for certification of the bolt catcher. The approach relied on incomplete testing, analysis, and similarity. The original testing and certification for this system was done in a configuration that did not adequately resemble the final flight configuration. Certification of flight critical systems by analysis and similarity, at least in the case of the bolt catcher was inadequate. Recommend NASA seek to identify other systems that were qualified inadequately, and re-perform certification.

Initiate an investigation into the nature of the object tracked on STS-107 at approximately the 126 second point to determine its nature and origin and whether or not it represents a threat to future Shuttle missions.

1.6 SEPARATION BOLT

Issue:

The separation bolts procured from a new contractor were not adequately inspected before flight on STS-107.

Background:

USA replaced Hi-Shear as the prime contractor for separation bolts in May 2000. Certification of new bolts may have

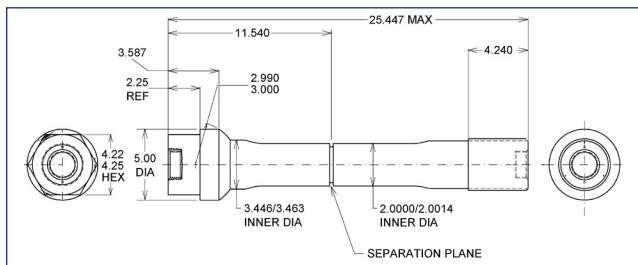

Figure 1.6.1. Separation Bolt.

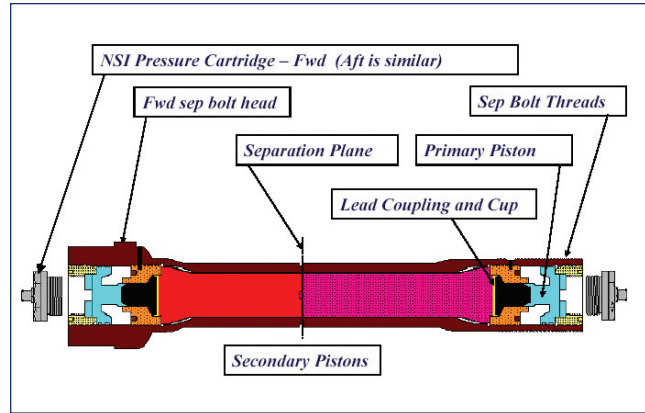

Figure 1.6.2. Separation bolt cross section.

been done without adequate NDI (magnetic particle) of the internal bore. (See Figures 1.6.1 and 1.6.2.)

Facts:

Hi-Shear manufactured all of the explosive bolts procured by NASA for the SSP up to approximately three years ago. Escalating price and problems meeting delivery schedules drove NASA to seek a second source. Pacific-Scientific Energetic Materials Company (PS/EMC) of Chandler, Arizona won the down select competition and was qualified as a manufacturing source using the same configuration and specifications as Hi-Shear. Approximately 40 separation bolts were produced for certification testing and (after approval) use on future Space Shuttle missions. After bolt housings are machined, grooved and proof loaded, PS/EMC sends housings to Pacific Magnetic & Penetrant (PMP) Inc., in North Hollywood, California to perform inspection of the inside diameter (ID) of the bolt housings using magnetic particle inspection.

STS-107 was the first flight of the new PS/EMC bolts. They were installed on both of the forward (upper) SRB/ET attach points. Previous flights used the remaining stock of Hi-Shear bolts. Shortly after the *Columbia* accident it was discovered (source unknown) that the new bolts may not have been correctly Non-Destructive Inspected (NDI) during the manufacturing process. On January 28, 2003, Forward Separation Bolt housings, Lot AAP, were tested at PMP with USA PQAR, PS/EMC Quality, and DCMA in attendance.

Investigation by the DCMA NDI 3 level (certified expert in specific NDI technology) of the second lot of PS/EMC produced bolts, revealed that the Magnetic Particle Inspection (MT) of the ID of the bore of the hollow bolt had not been done with a borescope, thereby making adequate observation of the test area for machine-created flaws impossible, in his opinion. According to the DCMA expert, the NDI requires use of borescope in order to adequately see inside the narrow (around two inches) bore. The Purchase Order imposes a Magnetic Particle inspection per ASTM E-1444-01 for the Forward Bolt Housings. His assessment referenced MCD2-502470-01 Rev. (N/C), paragraph 4.11, which states in part all internal and external surfaces, shall be inspected by con-

tinuous wet method. Each bolt housing shall be subjected to Magnetic Particle Inspection and, under ASTM E 1444, Paragraph 5.7.3 “Restricted Area Examination” states in part: “where lamps are physically too large to directly illuminate the examination surface, special lighting, such as UV pencil lights or UV light guides or Borescopes shall be used.”¹⁰

The PMP borescope was not operational and was not used to inspect the ID of Lot AAP. USA had verbally instructed PMP to deviate from the Pac-Sci purchase order, providing that the borescope need not be used but a more stringent rejection criteria be applied (any indication). Due to the MT process concerns on Lot AAP, Lot AAN is also in question. Lot AAN bolt housings were used on STS-107, as well as, in the assembly of STS-114.

A process demonstration was conducted at PMP on March 5, 2003 using a test housing with simulated, intentionally induced, machining flaws. A Joint USA/DCMA team agreed to this NDI flaw standard (bolt with known and induced failures) test as means to validate the PMP process. The PMP Level II NDI technician used the same procedures as were used on the production lot and discovered 12 of 17 defects. This was consistent with the test dry run done previously at Wiley Labs using a similar Magnetic Particle Technique. All defects consistently found were 0.25 inches and above which is in compliance with MSFC STD 1249 established for this contract. Initial critical flaw size was re-baselined in 1988 to allow a flaw of 0.258 inches. Armed with these test results and consultation with other NDI experts, USA concluded that a borescope is not required and a dental mirror will provide adequate range of visibility.

Without photographic or physical evidence from the External Tank, an alternative method was needed to verify function of the new bolts used in STS-107. The STS-107 recovered bolts (bottom halves) from the SRB side of the attachment fixture were examined and found to be within design parameters. They were not inspected but rather evaluated for function. The remaining 10 bolts have been sequestered and will not be flown. USA intends to use these bolts in test only. PS/EMC and their NDI subcontractor are being requalified for explosive bolt production.

Proposed Recommendations:

Inspection of the inside diameter without a borescope may be adequate (arguably) but more thorough analysis would improve the confidence margin for success. NASA/USA should consider more stringent inspection criteria in accordance with ASTM E 1444, par. 5.7.3, Restricted Area Examination using a borescope or a different NDE technique.

The investigation determined that the Lot AAN forward bolts flown on STS-107 functioned per design and were consistent with performance of previous lots of forward bolts. The separation bolt is not believed to be a contributor to the STS-107 accident. Implications for the Space Shuttle Program are minimal; however, process and configuration controls may be inadequate if the process of changing manufacturing sources results in product deficiency or specification compromise.

1.7 LEADING EDGE SUPPORT SYSTEM (LESS) HARDWARE USE

Action/Issue:

Review and assess Orbiter LESS maintenance practices regarding hardware use.

Background:

The Orbiter’s wing leading edges are subjected to thermal and aerodynamic stresses during reentry. Proper inspection and maintenance of the LESS components, including attaching hardware, are essential to the system performing as designed/intended. The LESS consists of: 22 Reinforced Carbon-Carbon (RCC) panels on each wing; 44 carrier panels (22 on each wing’s upper and lower surface); numerous other components (such as spar insulators, clevis insulators, spanner beam insulators, spar attach fittings, and brackets); and hardware (including bolts, pins, and sleeves). See Figure 1.7.1 for details.

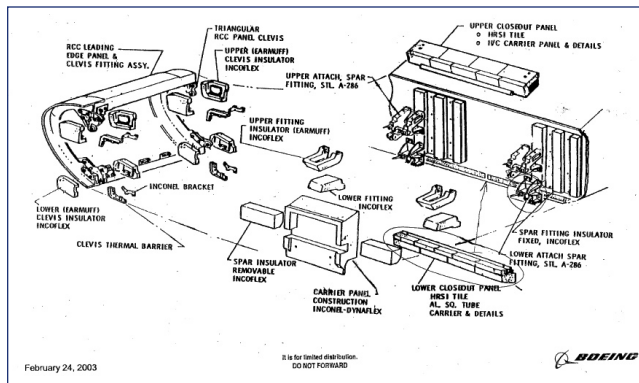

Figure 1.7.1. Details of the wing Leading Edge Support System.

Findings:

Reviewed Work Authorization Documents (WAD) covering carrier panel removal and installation for both lower and upper carrier panels. Also reviewed WADs for removal and installation of RCC panels. WADs are very specific on most tasks with one exception: carrier panel hardware (A-286 bolt) inspection and reuse.

Each upper carrier panel is secured with four bolts, and each lower carrier panel with two bolts. Upon visiting Orbiter Processing Facility (OPF) 3, where *Discovery* was undergoing Orbiter Major Modification (OMM), engineers initially stated these bolts are cleaned using isopropyl alcohol, inspected, and reused. Technicians stated they typically discard the hardware following carrier panel removal and replace it upon installation. Inspection of multiple carrier panel storage containers revealed carrier panels and associated paperwork, but no hardware. After further discussion, engineers restated bolts “can be reused” at the technician’s discretion, based on cleaning and visual inspection.

Review of the WADs associated with carrier panel removal

and installation showed no requirement to clean, inspect, reuse, or replace hardware. In contrast, the WADs covering RCC panel removal clearly state "...identify, bag and retain hardware for future use" with respect to four separate, associated components. Physical inspection of removed RCC panels verified associated hardware properly bagged and identified.

Conclusions:

Inconsistent/lacking guidance allows for different interpretations and creates the potential for process variation(s).

Proposed Recommendations:

Eliminate the potential for varying interpretations of carrier panel bolt use by making WADs more specific.

1.8 COLUMBIA HARD LANDING

Action/Issue:

Review NASA's assessment of *Columbia's* hard landing on STS-90.

Background:

Columbia made a hard landing during STS-90 (May 1998). Based on the combination of a 231,342 pound landing weight, 11 knot crosswind, and 6.7 feet per second (fps) sink rate, the established design criteria impact of 5.97 fps was exceeded by 12 percent.

Findings:

The main gear impact of 6.7 fps was estimated by using camera data and several techniques with reasonably close agreement. Crosswinds at the time of landing ranged from 4 to 11 knots and, for the assessment, the worst case (11 knots) was used.

Based on a 6.7 fps sink rate and 11 knot crosswind, reconstructed gear loads were determined to be less than half of design limit load. Figure 1.8.1 shows how energy levels decrease with lower sink rates and landing weights and explains how design criteria can be exceeded without exceeding structural capability. This was verified using MADS accelerometer and strain gage data.

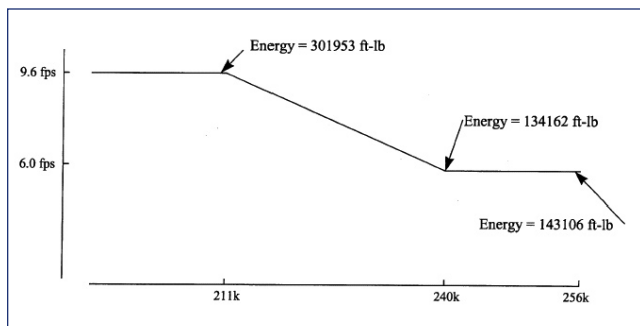

Figure 1.8.1. Energy Levels Based on Sink Rate/Landing Weight.

These results were reviewed and approved by the Orbiter Structures Team on July 14, 1998.

Conclusions:

Based on further study and analysis, including reconstructed main landing gear loads and energy comparisons, *Columbia's* landing during STS-90, while exceeding the design criteria, was determined to be well within structural capability.

Recommendations:

None. Eliminate as a causal factor.

Source: Boeing briefing, STS-90 Hard Landing Follow-up Actions, ORB, July 28, 1998.

2.0 MAINTENANCE REQUIREMENTS DETERMINATION

2.1 TECHNICAL DATA/SPECIFICATIONS

Action/Issue:

The backlog of Engineering Order (EO) updates is excessive and NASA's action to address prior independent assessments is inadequate.

Background:

NASA uses engineering drawings as the basic source document for all of its maintenance and engineering work on the Orbiters and Space Shuttle components. System engineers use these drawings to develop specific instructions (called Work Authorization Document, or WAD) for every repair or maintenance action. Updates to the drawings (required when a system is added or modified) are called Engineering Orders until they are incorporated into the drawing. The backlog of unincorporated Engineering Orders is a well-documented concern that has plagued Orbiter processing and maintenance for several years. Admiral Cantrell, in his briefing to the Board on the NASA-Navy Benchmarking Exchange, recommended NASA use the Navy SUBSAFE program's zero level as a baseline for technical data currency. This issue has been repeatedly presented as a finding in the Aerospace Safety Advisory Panel (ASAP) reports for 2001 and 2002. The 2002 ASAP report states:

"Previously, the Panel has been concerned with the large number of Orbiter drawings that are out of date. Many EO changes have not been incorporated into the drawings. Although they are noted on the drawings, engineers must refer to additional paperwork to understand the state of the hardware systems. Over 1600 drawings have more than 10 unincorporated EOs. The Orbiter program will update and incorporate all EOs on 59 of the most frequently used drawings by the end of 2003. Also during the year, an effort to address the 589 drawings referenced most frequently after those 59 will begin. Orbiter program management has committed to maintaining the upgraded drawings at no more than 10 unincorporated EOs. The Orbiter Project is now

reviewing the possibility of identifying the safety-critical drawings that should always be kept current. Recommendation 02-8: Identify drawings that are critical to flight safety, update them to include all EOs, and keep them current.”¹¹ (See Figures 2.1.1 and 2.1.2.)

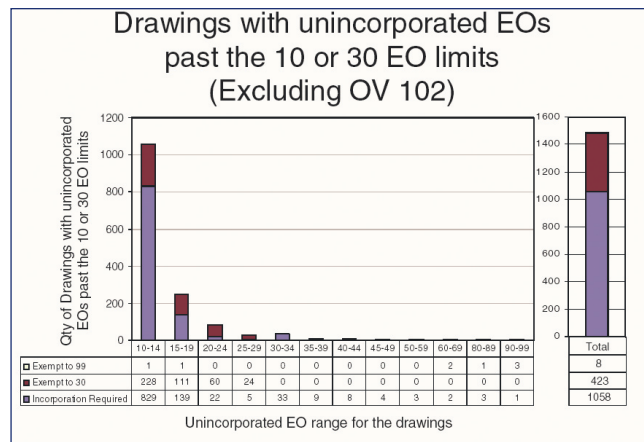

Figure 2.1.1. Unincorporated Engineering Order statistics.

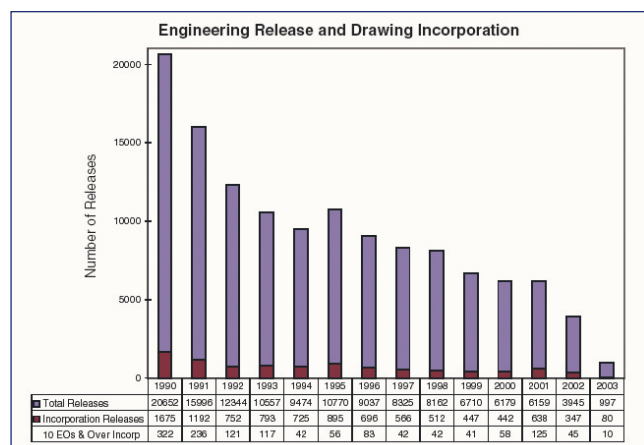

Figure 2.1.2. Engineering Release and Drawing incorporation statistics.

Findings:

The Navy’s SUBSAFE program identified 1,600 technical drawings, out of approximately 33,000, that are critical to a boat’s ability to surface in an emergency. All of this technical data must be current before a sub is approved to sail. The approval process is run very much like a Shuttle CoFR and includes maintenance, operations, program and engineering input to certify the boat for the next sortie. Out of date drawings are criteria to withhold the certification.

The Navy’s SUBSAFE program is not an isolated example of successfully maintaining technical data integrity. Boeing-Rocketdyne, the original equipment manufacturer, manages the Space Shuttle Program’s main engines as well as contract maintenance and logistics. The drawings and source specifications for the SSME are maintained in their legacy system called the Engineering, Manufacturing, and

Planning Log. In 1996 Boeing began a program to digitize all of their technical data, which is now complete. Master documents have been developed for most predictable tasks performed on the engine such as remove, replace, or inspect. Any changes to the specifications or master documents, by virtue of a program or configuration change, are logged into the system and automatic tags or lock outs prevent use of all related technical instructions until that change has been incorporated or digital “red line” data is approved by the engineer. Red line data (edits normally used temporarily for unique tasks) are not used more than three times before the program locks it out for mandatory update to the master document. Updates to the technical data are rigorously reviewed and approved but relatively easy to enact in digital format.

Members of the Board staff visited with USA managers at both the NASA Shuttle Logistics Depot and OPF 3 (J3 OMM in progress on OV-103) to evaluate the impact of unincorporated EO changes on Shuttle maintenance. Observations of the EO system, in use, revealed the difficulties of navigating the technical data with multiple unincorporated EO changes and the potential for human error. This observation was also documented in an April 2001 independent study. “The high quantity of EOs on some engineering drawings is causing confusion, slowing the workflow and providing a potential error source for technicians who must comply with the drawing specifications on the shop floor... Compared to airplane manufacturers or government military programs, the current Space Shuttle system... is very liberal.”¹² NASA has built a noteworthy plan to incorporate the most important changes to drawings, for Orbiter, on basis of highest use and complexity (2002-2004). This program, as discussed above, will cover a small number of the drawings and does not address the process that NASA will adopt to maintain them at that level.

Delays in work progress are routinely experienced due to the necessity to review all unincorporated changes before proceeding with a maintenance action. According to the technicians, there are routinely many unincorporated changes and it is not unusual for one change to be “unchanged” or nullified by a follow-on EO change. Frequently, significant delays are created when inconsistencies between the EO, unincorporated changes, and the actual component or vehicle do not correlate to one another. This complexity delays maintenance and creates another vulnerability in the system for human error due to interpretation or oversight. When engineers are drafting WADs for use on the OPF floor, they must navigate through the drawings as well as all of the engineering orders. This process is labor intensive and open to human error as well. During the Board’s paper review of STS-107, one of the findings in the SSME area was an incorrect torque specification taken directly from the drawings and EOs (even after three layers of review in the office prior to being issued as a WAD). Every Space Shuttle mission may result in a large number of changes to the drawings. In most many cases, the pace of new changes is significantly greater than the pace of updates.

During the Board’s investigation of *Columbia’s* wreckage, progress was significantly hampered by a lack of accurate and up to date drawings of OV-102. Data acquired from the

OEX recorder referenced sensor readings that did not exist in *Columbia's* engineering drawings or the engineering orders. Fortunately, photos taken at the conclusion of *Columbia's* J3 OMM (called close-out photos) showed the cables and their location inside the wing. These closeout photos are a part of NASA's routine documentation of ground processing at KSC. The Operating Procedure for Hardware Photographic Documentation provides guidance for when these photos are required: "1. Closeout photos are to be taken to document the as-assembled condition of flight hardware. 2. Closeout photos are to be taken of normally closed areas (areas not visible due to the installation of panels, trays, fairings, blankets, etc.) only when planned or unplanned work or problems result in the removal and reinstallation of functional system components."¹³ During the investigation these photos helped pinpoint the sequence of events as the hot gases spread throughout *Columbia's* left wing. However, there were a few problems discovered that delayed progress further. First, the effort to recover these photos from NASA's database was extensive, taking up to six weeks. Photos are kept in different databases (manual and digital) for the various Shuttle components (Orbiter, Space Shuttle Main Engines, Solid Rocket Boosters, and External Tank). Kennedy Space Center files the close out photos in the Still Image Management System (SIMS) and is referenced in the database that the WADs are stored in (Shuttle Processing Electronic Archival and Retrieval System, SPEARS). It took up to 6 weeks to recover the internal wing photography for *Columbia*. Second, the photos documented the closeout of the particular WAD but did not adequately show all of the wiring that deviated from the engineering drawings. A systematic method to photographically document (panoramic or sequential pictures showing the entire wire bundle or system) all of the divergent system is not specified in the guiding Operating Procedure.

The problems with out-of-date engineering drawings and the time delay to retrieve close-out photos led investigators to the conclusion that NASA may not be able to rapidly or accurately respond to a future in-flight emergency. In such a scenario there may only be a few hours to reference source documents and pass instructions to the crew. Analog systems, filed in various locations, with potential inaccuracies based on unincorporated (or missing as in the case of sensor wiring on *Columbia*) engineering orders may make rapid response impossible or lead ground controllers to provide erroneous direction. NASA/USA has identified and prioritized the backlog using a most-used/most-critical methodology. NASA responded to a Board request for information regarding the status of the unincorporated EOs with the following answer:

At the present time, 1,489 drawings (1600, excluding OV102 only drawings) have more than 10 Engineering Orders (EO). Orbiter drawings have a requirement to be updated after 10 EOs, but exemptions have been allowed on some drawings to have up to 30 and 99 EOs. Of the 1489 drawings, 431 drawings have exemptions to go beyond the 10 EO requirements, which leave 1,058 drawings that do not have exemptions. The Vehicle Engineering office and KSC Operations office have prioritized these drawings with outstanding EOs and determined that 325 drawings (of the 1,058) have

significant KSC interaction. The Vehicle Engineering is currently incorporating the outstanding EOs on these 325 drawings. Incorporating the remainder of the 1,058 is not prudent because these drawings are rarely used.

In 2002 the Space Shuttle Vehicle Engineering Office (SS-VEO) started allocating money for EOs incorporation. This task is funded to incorporate 20 to 30 drawings worth of EOs per year (depending on the number of EOs open against a drawing). In addition to the scheduled planned EO incorporation, EO incorporation is also performed through updates to drawings due to other modifications affecting those drawings. At this rate, approximately 8 to 10 years will be required to update all 325 drawings.¹⁴

Figures 2.1.1 and 2.1.2 show the status of the Shuttle Program's technical data in two graphics. The first shows the number of drawings that have greater than 10 unincorporated EOs each. The total figure, as mentioned above is 1,058. However, the significance of this number is further emphasized in the columns that have larger numbers of unincorporated changes but are supposed to be limited to no more than 10 unincorporated changes. Specifically, 90 have more than 20 EOs and 21 have over 40 unincorporated changes. The second graphic shows the number of total releases (new or updated technical drawings or specifications) by year. Over the last 10 years there has been a steady decrease in the number of new releases but incorporations have remained at a significantly lower level and at a relatively slow pace. In 2001 NASA accelerated this pace and has continued at this rate since then.

This process only addresses the most commonly used drawings, and their EOs, and therefore leaves hundreds of EOs remaining. The process to update analog drawings is expensive and time consuming. This backlog will continue to grow with return-to-flight recommendations and the pace at which engineers make systems changes for mission and safety. Until NASA funds a digitally based engineering and technical data system this process will continue to be labor and capital intensive. The repeat nature of this issue and NASA's response to the Board leads to the conclusion that NASA considers this issue to be problematic. In other words, there has been a corporate decision to accept this level of backlog and its not considered to be an issue. NASA should take immediate action to significantly reduce the backlog of unincorporated engineering orders and accelerate the time to update them. Using a digital system to update the commonly used or highly critical technical data will be initially more expensive but significantly more flexible for future updates.

Proposed Recommendations:

The current status of engineering drawings and engineering orders is inadequate to support the Shuttle Program for another 20 years. NASA should significantly accelerate the update of critical EOs and build a plan for the remaining majority of EO updates to minimize vulnerability to human error and improve maintenance efficiency. Highly recommend they consider digitizing the data to streamline the process to facilitate more rapid updates and retrieval in an emergency.

The current status of engineering drawings, engineering orders, and closeout photos will not support rapid crisis resolution such as an on-orbit event. NASA must, before returning to flight, develop a system(s) that ensures engineering drawings, unincorporated EOs, and closeout photos, (processing and manufacturing, where applicable, for all Shuttle systems) are readily accessible to support crisis resolution.

2.2 SAFETY & MISSION ASSURANCE

Issue:

The adaptation of NASA's Safety & Mission Assurance (S&MA) under the changing environment with several contractors raises concerns over scope and depth of program insight and oversight.

Background:

NASA and contractors' assurance programs have undergone considerable change over the past five years. The transition to the Space Flight Operations Contract (SFOC) significantly changed the role of NASA S&MA inspectors as well as the relationship between NASA's other centers and their contractors. Much attention has been paid to the adequacy of government oversight in validating USA's work, the Safety, Quality, and Mission Assurance (SQ&MA) verification of work performed and the number of government mandated inspection points (GMIP). NASA's Shuttle Processing Surveillance Plan employs surveillance in accordance with KDP-P-1693, Surveillance of SFOC Activities at KSC. The KSC Shuttle Processing Directorate's Engineering, Logistics, and S&MA Divisions and the Shuttle Project Office perform a dual insight/oversight role and are responsible for evaluating contractor performance and verification of maintenance for flight readiness. Ultimately this (and many other factors emanating from the various subsystems and centers) is considered in the flight readiness review process and culminates with the signing of the Certification of Flight Readiness (CoFR).

The NASA quality program has significantly evolved in scope and depth, with a transition from an intensive, comprehensive inspection regimen, to one based on risk-analysis. At Kennedy, in 1989, 300,000 inspections were accomplished by contractors, with an additional 44,000 performed by NASA inspectors. Today, an estimated 140,000 inspections are accomplished by USA, with approximately 8,500 inspections conducted by KSC S&MA. MSFC went through a similar process that reduced their inspection workload (1990: 49,000 GMIPs, 821,000 contractor inspections, 2000: 13,300 GMIPs, 444,000 contractor inspections, 2002: 13,700 GMIPs, 461,000 contractor inspections) as did most of the NASA centers. Inspection requirements are specified in the Quality Planning Requirements Document (QPRD). For a single Shuttle maintenance flow, an estimated total of 730,000 tasks require "T-stamp" documentation by USA technicians. Of those tasks, approximately 140,000 tasks require "Q-stamp" verification by USA SQ&MA, with 8,500 of those tasks requiring "N-stamp" by NASA S&MA inspectors (GMIP). All tasks assessed as Criticality Code 1, 1R (redundant), or 2 are inspected 100 percent of the time,

as are any systems not verifiable by operational check or test prior to close out.

Findings:

The NASA/USA quality assurance processes are not fully integrated with each other or the Safety, Health & Independent Assessment and engineering surveillance programs. Each one, separately, plays a vital role in the control and assessment of the product as it comes together in the OPF or shop. The four together represent a nearly comprehensive quality control process but require integration and additional sampling-based inspections to flesh out the assurance process. MSFC has a similar challenge. They are responsible for the management of several different Space Shuttle systems through contractors that maintain data in various (mostly proprietary) databases. Integration between the systems is limited with the exception of the Space Shuttle Main Engine (SSME), which uses PRACA to document nonconformances as well as a proprietary database. However, they overcome a lot of this challenge by being centrally organized under a single S&MA division chief that reports to the center director. KSC has a separate S&MA office working directly for each program, a separate SH&IA office under the center director, and separate quality engineers under each program. Integration of the quality program would be better served if this were consolidated under one S&MA office reporting to the center director.

Application of industry standard quality sampling and analysis techniques is inconsistent. SQ&MA (and other NASA contractors) sample a large amount of their workload. S&MA samples USA work informally (but is officially discouraged) and results are only documented in the S&MA Safety & Mission Assurance Reporting Tool (SMART) database. SMART is used by NASA S&MA as a quality problem-tracking tool to help them identify trends in findings and focus their approach to oversight and insight. Problems revealed by the sampling inspections or from the informal SMART database can be communicated to USA through the USA QCAT system but there is no contractual requirement for USA to respond or even take corrective action. MSFC samples contractor work but does not use any preplanned, statistically based approach or analysis. The Space Shuttle Processing Independent Assessment Report of 2001 documented this succinctly; "Process surveillance as it exists today is not accomplishing its desired goals nor is it a true measure of the health of the work processes, as was its original stated objective. "¹⁵ Sample-based inspections should include all aspects of production, including training records, worker certification, etc., as well as FOD prevention. NASA should also add all process inspection findings to its metrics program, including processing debris. Emphasis should go beyond "command performance" formal inspection events to validate USA quality inspection results.

The engineering assessment of work paper, which is accomplished without use of structured sampling methodology or consistency across the various systems/subsystems, is another example. Every work assignment document is reviewed by up to three additional engineers. Additionally, the Technical Accuracy Measurement system outlines

a review of WADs at the system or subsystem level but does not specify frequency or quantity using statistically representative methodology or use of this information for trend analysis. This is just one system example of a review process used by one subsystem. This very issue was addressed in an independent assessment report; “The goal of USA’s work procedure improvement programs need to be continued and expanded to remove inconsistencies and inaccuracies, incorporate deviations and clarify procedural steps. The better the work documentation is, the greater the procedural compliance, and the less chance for error. USA should investigate the consolidation of the many separate initiatives for improving work documentation into one cohesive, integrated program.”¹⁶

The list of NASA S&MA oversight inspections (GMIP) was based on engineering risk assessment with limited application of quality analysis and sampling techniques in determining the scope and frequency of inspections. Tasks were retained for government oversight on the basis of criticality, not process or quality assurance. Marshall S&MA retained government oversight options during their GMIPs reduction; by moving all the former GMIPs into a new category they call Surveillance Opportunities (SO). These “opportunities” are no longer mandatory oversight inspection points but remain as an optional area for S&MA inspection. Thiokol actually calls the S&MA shop with 15 minutes warning when a SO is occurring, but will not (by agreement) wait for the inspector in order to maintain job flow. These inspections are not statistically driven. USA inspectors accomplish additional assessments by sampling 40 different production processes such as personal protective equipment (PPE) use and clean as you go, in addition to planned task inspections. The contractor cited an 80 percent confidence level in the sampling’s effectiveness in evaluating daily compliance per established processes and practices. The MSFC S&MA system includes feedback and closed loop systems to use in trend analysis and in developing future S&MA tasks to improve oversight and quality. S&MA observed events that result in a Verbal Corrective Action Report are included in this tracking system and used to tailor surveillance or GMIPs.

Several reports have documented organizational inconsistency within the NASA quality assurance construct. The October to December 1999 Space Shuttle Independent Assessment Team report echoed the Rogers Commission Report by including a lengthy discussion of the need for organizational independence and a strong S&MA presence.¹⁷ “The SIAT believes strongly that an independent, visible Safety and Mission Assurance function is vital to the safe operation and maintenance of the Shuttle. The Shuttle Program in its ‘one strike and you’re out’ environment is unlike most other defense or commercial industries. As a consequence, it is believed the industry trend toward reducing Safety & Mission Assurance oversight and functions is inappropriate for the Shuttle.”¹⁸ Among their recommendations was a strong mandate to restore surveillance.¹⁹ This is consistent with the testimony of several S&MA inspectors to members of the Board.

NASA’s S&MA quality assurance organization has experienced some challenges with its quality assurance inspector

workforce as leadership works to evolve the business relationship with the contractor and the inspector culture. Some inspectors, who assert that more GMIPs are necessary, tend toward an adversarial approach, which may discourage the contractor from disclosing problems or noncompliance issues. One senior manager suggested that GMIPs may not be “all in the right place,” and should be reviewed/selected by application of statistical sampling techniques in addition to the current practice of risk assessment. This same individual proposed that the engineering sampling of work paper should be statistically based, to ensure that the data gathered is representative.

The significant reduction of GMIPs tasks over the last 14 years (in 1989, 300,000 inspections were accomplished by contractors, 44,000 by NASA inspectors, today, an estimated 140,000 inspections are accomplished by USA, approximately 8,500, at NASA-KSC) was accomplished by a rigorous review of all Category 1, 1R and 2 tasks and areas of concern that would be impossible to observe later. Many of the inspectors interviewed by Board members felt strongly that this number is inadequate and that the process to adjust the level is intentionally inflexible. One example cited was a request to add a main engine final review prior to transport from the shop to the OPF for installation. Their rationale is that the engine is on a rotary stand and in the best position to inspect. The effort to add this task as a GMIP started approximately two years ago and has repeatedly been denied on the basis of inadequate staffing. S&MA’s response has been to continue doing it informally. The process to adjust GMIPs tasks is constrained by the belief that the level was set on strong engineering logic and should need no adjustment. This may be predominately true but leaves out any options for quality assurance to respond to a changing environment in terms of an aging system, workforce dynamics, or process improvement initiative.

The Marshall GMIP process is overseen by the quality engineer in charge and has proven over the last two years to be significantly more flexible than KSC. They, like KSC, do not have a regular process to review either GMIPs or surveillance inspections. However, Marshall’s use of former GMIPs (SO) to ensure adequate government oversight relieves their concern about too few GMIPs. NASA should build a regular (at least annual) process to review S&MA, contractor, and PRACA databases to adjust GMIPs and sampling goals to assure mission success, contractor compliance and provide more accurate insight/oversight.

Feedback to members of the Board reflected that NASA QA inspectors feel they do not have authority (or are discouraged from doing so) to reject USA work. Consequently, NASA S&MA does not track reject rates (hexagonal-shaped stamps applied to WADs by S&MA inspectors) for occurrences in which a NASA QA inspector might reject a job closed out by a USA quality inspector. They also assert that inspectors are only authorized to use their Hex stamp to notify the contractor to “stop work.” Use of the Hex stamp is apparently rare, presumably due in part to overall inspector reluctance or potentially NASA’s lack of metrics to track hex stamp issuance. The following data was retrieved for use in this report. Total inspections conducted from FY2001 through

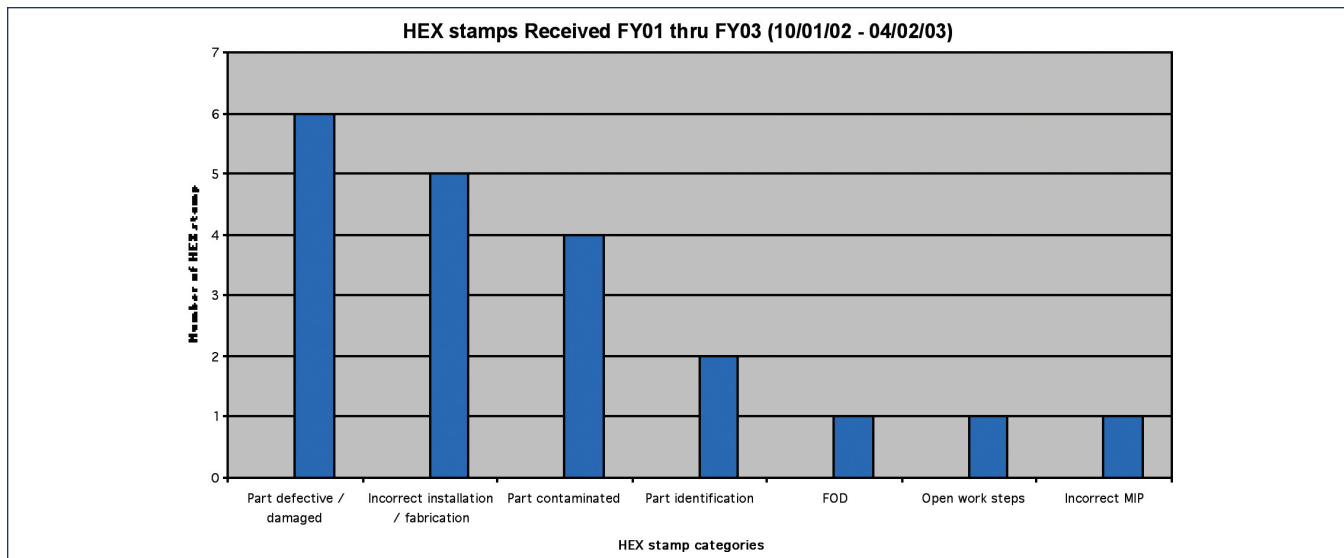

Figure 2.2.1. HEX stamps received between October 1, 2002 and April 2, 2003.

March 2003 that would have been subject to potential hex stamp use were 141,247. During that same period only 20 hex stamps were issued for various operations. (See Figure 2.2.1) HEX stamps received in FY2001, FY2002, and current FY2003 have been reviewed and the conclusion drawn is that the number of HEX stamps received compared to the number of inspection opportunities and hardware items completed/shipped provided too few data points for extensive analysis. According to several sources, this practice has been curtailed due to previous practices of using the stamps as a “hammer” against the contractor. The more common practice is for the inspector to refuse to buy the discrepant job, and offer to come back later once corrective action is taken. Such instances are not tracked by any measurement.

Use of metrics appears to be of inconsistent effectiveness. NASA staff offered the following quotes:

“Collection of metrics is rampant; but the utility and the analysis of that data is questionable and lacking.”

“A lot of metrics are kept, some with no value added, little true management using metrics.”

“The CAIB could help NASA understand how they can use metrics more effectively.”

“Assessment of contractor performance is largely anecdotal.”

“Very few leading metrics are used; predictive metrics are very hard to develop/use”²⁰

When asked if people were their most constrained resource, NASA S&MA leadership cited that while the number of quality assurance people may be adequate, if they had more people, they could be more responsive during workload peaks to avoid workers having to wait for an inspector to close out a job. One member stated that the situation was

much improved since 2000, when the organization had zero quality engineers and many issues had to be deferred to system engineers. The USA representative stated that the staffing situation had improved considerably since the program’s transition from California. Additionally, while USA may have enough people in SQ&MA, the organization would benefit with more personnel to be used in industrial and human factors engineering to accomplish more process assessments and analyses. One of the more common reasons quality engineers declined to add GMIPs was cited as inadequate manpower. The 1999 SIAT²¹ report documented its concern with the declining manpower pool and approximately 35 new inspectors were added at KSC. Since then most of that increase has been eroded through retirements and promotions. Marshall’s S&MA staff is also short approximately 10 people. In both cases the replacement manpower is on hold due to budgetary considerations. We highly recommend that NASA review its S&MA manning.

The NASA S&MA chiefs are at a lower grade position relative to the Chief Engineer or Launch Director. This organizational structure may be problematic with respect to potential pressure in resolving conflicting priorities between respective organizations. NASA should review the position description and adjust to establish parity in leadership and influence.

USA’s Safety, Quality and Mission Assurance (SQ&MA) team has implemented a robust program to verify that work accomplished is in compliance with the OMRSD. USA has invested much effort in building a culture focused on quality and safety. Its “Time Out” program authorizes any worker to call a halt to operations, report problems/defects (even if only suspected), and is encouraged, even rewarded, by management. The NASA Shuttle Logistics Depot’s (NSLD) effort in building a safety focus has been recognized as an OSHA “Star Site” for its participation in this voluntary protection program. Recently re-certified in 2002, its workforce has gone 750 days (as of April 2003) without a lost-time mishap.

The NASA and USA Foreign Object Debris (FOD) prevention program should be reconsidered. FOD prevention programs typically fall under the auspices of Quality Assurance programs in the DoD and aviation industries. After the publication of the National Aerospace FOD Prevention, Inc (NAFPI) FOD Prevention Guideline in July of 2000, the FOD program was changed (took effect during the Award Fee Rating Period from March 1 through September 1, 2001) with FOD re-categorized into “process debris” and “FOD.” Processing debris is defined as “Any material, product, substance, tool or aid generally used during the processing of flight hardware that remains in the work area when not directly in use, or that is left unattended in the work area for any length of time during the processing of tasks, or that is left remaining or forgotten in the work area after the completion of a task or at the end of a work shift. Also any item, material or substance in the work area that should be found and removed as part of standard housekeeping, Hazard Recognition and Inspection Program (HRIP) walkdowns, or as part of “Clean As You Go” practices.”²² Foreign object debris or FOD, is defined as “Processing debris becomes FOD when it poses a potential risk to the Shuttle or any of its components, and only occurs when the debris is found during or subsequent to a final/flight Closeout Inspection, or subsequent to OMI S0007 ET Load SAF/FAC walkdown.”²³ The rationale for including this step as a mandatory inspection point was that the area was put into use at the closeout; therefore, any debris found at that time was no longer “potential FOD” but was FOD.

make the aerospace industry aware of the need to eliminate foreign object debris and provide information about current proven practices and technological advancements that prevent FOD.... An effective FOD prevention program identifies potential problems, corrects negative factors, provides awareness, effective employee training, and uses industry “lessons learned” for continued improvement.”²⁴ There is no mention of Process Debris but it does talk to potential foreign object debris. NASA has done a good job of complying with almost every area of this guideline. However, the document addresses FOD investigations in a singular sense. “All incidents of actual or potential FOD should be reported and investigated. These reports should be directed to the FOD Focal Point who should perform tracking and trending analysis. The focal point should also assure all affected personnel are aware of all potential (near mishap) /actual FOD reports to facilitate feedback (“lessons learned”).”²⁵

This FOD program redefinition was a result of a National Aerospace FOD Prevention, Inc. (NAFPI) conference that resulted in some new industry-wide initiatives. NAFPI is a “nonprofit, educational organization developed to standardize terms and methods for the prevention of foreign object damage to aircraft and aerospace vehicles. The objective is to

The NASA FOD program does have some outstanding aspects. The USA FOD program includes daily debris walk downs by management to ensure workers comply with the “clean as you go” USA policy. This program is noteworthy but statistics kept by USA show its success rate varies between 70 and 86 percent.²⁶ (See Figures 2.2.2 and 2.2.3.) The danger of migrating debris begins while the job is in work. FOD prevention must be considered as critical as clean up, regardless of timing and division of labor between USA and NASA quality responsibilities.

NASA inspectors may inspect areas prior to closeout but cannot take formal action (categorize debris found as FOD) for those observations made before closeout. The consensus among inspectors is that this program re-categorization was to decrease the impact of NASA SM&A-found FOD on the USA awards fee. This may be anecdotal but indicates a

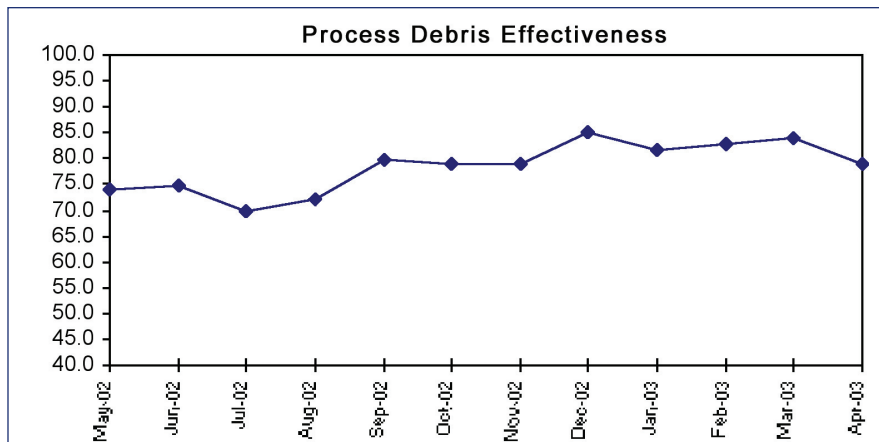
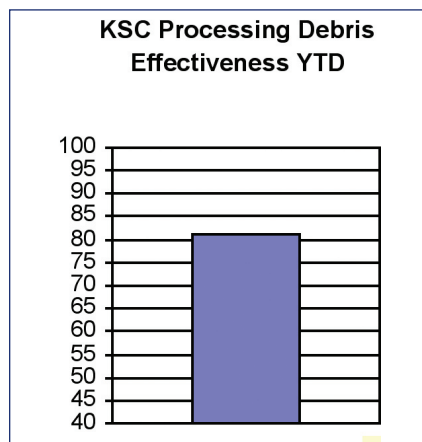

	####	####	Jul-02	####	####	####	####	####	Jan-03	Feb-03	Mar-03	Apr-03
# of Reports	660	486	546	556	427	487	427	331	424	345	367	373
# Debris Free Reports	489	363	382	400	340	385	337	282	347	286	308	295
# of Debris Findings	171	123	164	156	87	102	90	49	77	59	59	78
% effectiveness	74	75	70	72	80	79	79	85	82	83	84	79
Process Debris Rate	25.9%	25.3%	30.0%	28.1%	20.4%	20.9%	21.1%	14.8%	18.2%	17.1%	16.1%	20.9%

Figure 2.2.2. Process debris performance metrics.

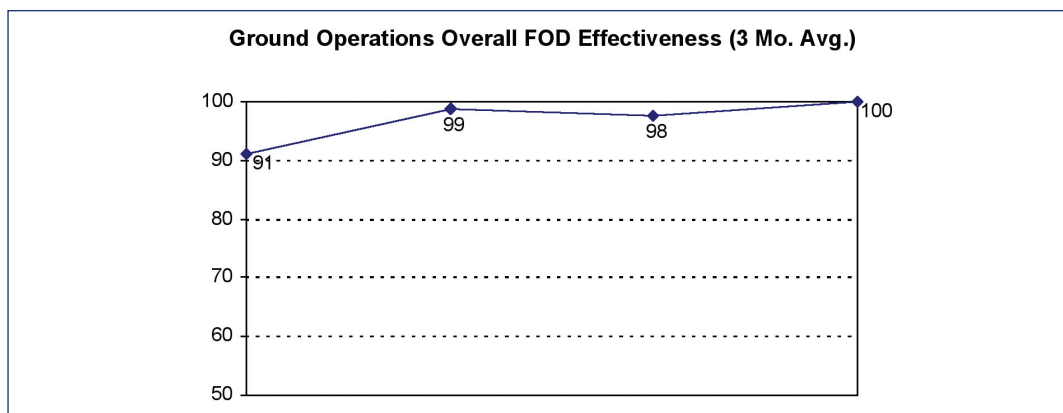
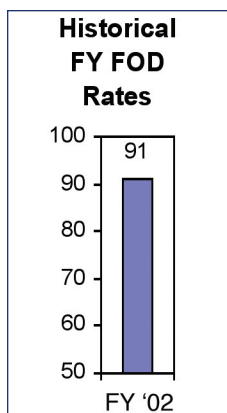

		FY '02						FY '03					
		APR - JUN			JLY - SEP			OCT - DEC			JAN - MAR		
# of Closeout Inspections		205			172			83			60		
# FOD Free Closeouts		187			170			81			60		
		APR	MAY	JUN	JLY	AUG	SEP	OCT	NOV	DEC	JAN	FEB	MAR
STS 107	# INSPECTIONS	21	45	48	1	1	0	3	8	9	6	0	
	# FOD FREE	18	36	42	1	1	0	3	8	9	6	0	
STS 114	# INSPECTIONS	0	1	4	0	0	0	0	1	10	38	1	
	# FOD FREE	0	1	4	0	0	0	0	1	10	38	1	
OTHER	# INSPECTIONS	34	23	29	52	42	76	28	21	3	2	13	
	# FOD FREE	34	23	29	52	41	75	27	20	3	2	13	

Figure 2.2.3. NASA FOD Metrics.

broad misunderstanding brought on by the recategorization and potentially a need for recurring (not presently required) training to reemphasize FOD prevention. Process debris statistics do not directly impact award fee. The award fee calculation for the last half of FY2002 resulted in the highest award in the history of the SFOC relationship. FOD rates for that period were at 91 percent and the process debris metric in the low 70s. This delineation of FOD is unique to the SFOC. NASA should recombine their FOD prevention program and increase its impact in the contract award fee. Since processing debris (or Potential FOD as it is called in the NAFTI guideline) and FOD are verifications, recommend the inspections be sequential (i.e., contractor inspects and then NASA inspects).

FOD prevention practices at the launch pads consist of 23 separate checks, from pre- to post-launch, accomplished in varying levels of detail by a broad range of personnel from different organizations. Implementing FOD prevention requirements for subcontractors accomplishing major maintenance on launch pad structures is a significant challenge. USA personnel cited a recent incident in which a bolt estimated to be of 2 inch length was observed blown about during launch. USA has established excellent FOD prevention standards by which they hold subcontractors responsible for compliance. The Statements of Work define subcontractor requirements for FOD prevention, and USA FOD prevention training is provided to subcontractors for their work

crews. Subcontractors are required to sign a “Statement of Commitment for Prevention of Foreign Object Debris” accepting that FOD prevention will be enforced during implementation of all tasks associated with that contract. Work crews are required to “clean as you go.” USA field monitors, focusing on routine debris clean up and control accomplish work site inspections, and inspection for FOD is included in the Quality Planning and Verification Sheets. Finally, FOD prevention compliance is among the requirements for final inspection and acceptance of subcontractor work. FOD discovered on the launch pad prior to a mission has a direct impact on the USA award fee as a safety factor.

Proposed Recommendations:

Re-evaluate the Space Shuttle Program’s S&MA inspection program and implement changes to enhance its effectiveness, including the following:

Perform a risk evaluation of the current FMEA/CIL (including GMIPs), while assessing other tasks for possible GMIPs inclusion or exclusion as appropriate.

NASA S&MA establish a process inspection program to provide oversight into contractor daily operations, while in process, using statistically driven sampling. Inspections should include all aspects of production, including training records, worker certification, etc., as well as FOD preven-

tion. NASA should also add all process inspection findings to its metrics program, including processing debris. Finally, inspections should be designed to evaluate all areas of production through concurrent and sequential evaluations as well as GMIPs, surveillance, and sampling based inspection events.

Develop a regular (at least annual) process to evaluate the quality assurance program. As a minimum it should consider inputs from engineering, technicians, PRACA, contractors and quality metrics to adapt the following year's program. This will make the quality program more adaptive to the changing environment of an aging vehicle/infrastructure and concentrate inspections on developing problems to ensure quality. Highly recommend benchmarking the airline industry and DoD.

Engineering review of work documents should be accomplished according to statistical sampling methods, to ensure a representative sample is evaluated and adequate feedback into the process is communicated to resolve documentation problems.

Designate NASA S&MA as the singular focal point for development and oversight of all quality assurance programs to ensure a fully integrated program across all divisions. Elevate the role of NASA's S&MA senior leaders to a position of parity with the key decision makers involved in launch and critical operations. Commensurate with this recommendation is the need to organize coherently within NASA to eliminate center and program options and provide adequate independence. Centralized control of S&MA at the Center Director level should be enforced.

Revise NASA's role in the FOD program to expand inspector involvement and number of inspections. These revisions should include the addition of random process surveillance including FOD prevention requirements. Such inspections will provide a better means of crosschecking contractors' oversight.

The FOD program should be revised to eliminate any alternative definitions of FOD, such as "processing debris." "FOD" is an industry-accepted term, and the use of any other definition could be interpreted as diminishing the significance of items left behind during maintenance, irrespective of job signoff status.

The seriousness of FOD in the Space Shuttle Program must be communicated in fiscal terms allowing very little room for marginal performance. Changing the impact of FOD as a safety program in the award fee calculation will communicate this clearly.

Finally, NASA should re-evaluate their manning posture to accomplish the S&MA mission as it is currently defined and as a result of the above recommended improvements after a QPRD program review. Manning should be adjusted to a level commensurate with the effort required to support revised GMIP and surveillance levels.

2.3 MAINTENANCE DOCUMENTATION (WAD ACCURACY)

Issue:

Assess accountability/traceability of work papers/maintenance actions from the source to the technician accomplishing the specific task to proper documentation analysis/archiving.

Background:

Accountability/traceability of every action is critical to safe operation of the Shuttle. Members of the Board toured the TAIR (Test and Inspection Records) station in OPF-3, where OV-103 has been undergoing OMM (since August 2002). During the tour inspection, maintenance, and modification requirements in paper form were observed being distributed to various work groups: TPS, electrical-mechanical, structural, etc. Engineers were observed at the TAIR station reviewing paperwork and forwarding requests for Problem Reports (PR) to systems engineers located elsewhere at KSC. Additionally, the team observed Work Authorizing Documents (WAD) in a specific work center (electrical-mechanical) being reviewed prior to work commencing and tools/equipment determination by assigned technicians.

Quality Data Center is responsible for tracking all paperwork from job completion in the OPF through each coordination function. All papers end up in this organization, where they are scanned, electronically archived, and physically archived. On an average day, 15,000 pages are archived; 4,500,000 pages annually. This database forms the basis for PRACA, SPEARS and SIMS, all of which are used for trend analysis, metrics, historical research, and so forth. Typically, all documentation is archived prior to launch.

Findings:

The engineering assessment of work paper, which is accomplished with very limited use of structured sampling methodology, is inconsistently used across the various systems/subsystems. Every WAD is reviewed by up to three additional engineers in the USA SSME division. Additionally, the Technical Accuracy Measurement system outlines a review of WADs at the system or subsystem level but does not specify frequency or quantity using statistically representative methodology or use of this information for trend analysis. This is just one example of a review process used by one system. This very issue was addressed in an independent assessment report; "The goal of USA's work procedure improvement programs needs to be continued and expanded to remove inconsistencies and inaccuracies, incorporate deviations and clarify procedural steps. The better the work documentation is, the greater the procedural compliance, and the less chance for error. USA should investigate the consolidation of the many separate initiatives for improving work documentation into one cohesive, integrated program."²⁷ USA does limited sampling of WAD completion during process quality sampling but NASA S&MA apparently does little to none.

The Board asked KSC NASA/USA to review documentation for STS-107, STS-109, and OV-102's J3 OMM paper work with specific interest in gleaming any information,

relevant to the investigation, which may have been causal or may reveal areas of weakness to be considered for return to flight recommendations. NASA built a team (Process Review Team...PRT) of 445 NASA and contractor engineers and quality personnel, divided into eight system teams and two special purpose teams. The KSC PRT activities involved three separate analyses of as-run procedures. The System Engineering Work Authorizing Document (WAD) Review focused on the technical aspects of WADs, (i.e., the quality of the work paper and the performance to the work paper); the Assurance Engineering Review²⁸ provided an independent, assurance review of the as-run WADs, and the Systemic Analysis²⁹ focused on categories of observations and technical observations derived from analysis of the System Engineering WAD Review results. The result of their work was a list of Findings (potential relationship to the mishap), Technical Observations (technical concerns or process issues), and Documentation Observations (minor errors). The team reviewed approximately 16,500 WADs with an estimated sheet count in excess of 600,000 pages over a three-month period. The team only generated one Finding, related to the bipod ramp, and no observations that may have contributed to the accident.

The PRTs sampling plan resulted in an excellent database of observations and was documented in their report.³⁰ The general results of this review are included in Figure 2.3.1. The number of observations is relatively low compared to the total amount of WADs reviewed and give an apparent 99.75 percent accuracy rate. While this number is high, a closer review of the data shows some of the weakness in the system. The total Technical Observations of 2,847 out of the samples taken from the STS-107, STS-109 and OMM reviews are delineated into 17 categories. Five of these categories, E, F, G, H, and M are of particular concern for mishap prevention and reinforce the need for process improvement. Category E, entitled "System configuration could damage hardware" was observed 112 times. Categories, F, G, and H, which deal with poor incorporation of technical guidance, are of particular interest due to the Board's concern over the backlog of unincorporated engineering orders. Finally, category M, entitled "paper has open work steps," indicates that the review system failed to catch a potentially significant oversight 310 times in this sample. Figures 2.3.2, 2.3.3, and 2.3.4 give list the results in detail.

The USA review of this data resulted in 10 recommendations for remedial action to reduce the potential for recurrence of this problem. It is noteworthy that they recognize a need for action and have outlined a get-well plan to accomplish it. Their enumerated list of actions is provided below.

- Operations and Quality review all closed paper for un-worked steps
- OEL, INS & TPS Engineering review all their documents for correct specification callout
- ET, SRB, Payloads review all their documents for application of critical skills
- GNC, PVD, MEQ review their closed documents for "Not Performed Options" incorrectly worked
- Engineering review closed paper for Data Not Recorded within Specific Limits

- INS, ETM & OEL review documents for Drawing Requirements Incorporation
- OEL review documents for System Configuration and OMRSD deficiencies
- INS review documents for System Configuration deficiencies
- OMS review documents for correct OMRS application.
- All Engineering teams review their paper for correct hardware callouts³¹

	STS-107	STS-109	OMM
Findings	1	0	0
Technical Observations	1222	1304	321
Documentation Observations	3406	3419	Not Required
WADS Reviewed	6751	6946	2866

Figure 2.3.1. Database review results.

Total Technical Observations Summary Count	
STS:	107
Team - Report	All
Count	Tech. Obs. Type/Code
19	A - MR Rationale incorrect or missing
32	B - Summary/Conclusion incorrect or missing
2	C - System cleanliness level compromised
9	D - System config. could compromise data integrity or accuracy
38	E - System configuration could damage hardware
69	F - Drawing Reqts incorrectly incorporated, incomplete or missing
32	G - OMRSD Reqts incorrectly incorporated, incomplete or missing
222	H - Other specification incorrectly incorporated, incomplete or
9	I - Troubleshooting data analysis incomplete, incorrect or missing
7	J - Troubleshooting leads to incorrect conclusion
7	K - Retest incomplete, incorrect or missing.
93	L - Data recorded not within specified limits
200	M - Paper has open work steps (steps not bought complete)
97	N - Wrong steps worked (NP options incorrectly selected)
188	O - Critical skill requirements incomplete, incorrect or missing
177	X - Other
21	Z - Missing Document - Process Review Incomplete
1222	Total Tech. Observations

Figure 2.3.2.

Total Technical Observations Summary Count	
STS:	OMM
Team - Report	A - Struc/Mech & C - Electrical
Count	Tech. Obs. Type/Code
23	A - MR Rationale incorrect or missing
33	B - Summary/Conclusion incorrect or missing
7	D - System config. could compromise data integrity or accuracy
24	E - System configuration could damage hardware
19	F - Drawing Reqts incorrectly incorporated, incomplete or missing
34	H - Other specification incorrectly incorporated, incomplete or
1	I - Troubleshooting data analysis incomplete, incorrect or missing
2	J - Troubleshooting leads to incorrect conclusion
4	K - Retest incomplete, incorrect or missing.
7	L - Data recorded not within specified limits
42	M - Paper has open work steps (steps not bought complete)
9	N - Wrong steps worked (NP options incorrectly selected)
39	O - Critical skill requirements incomplete, incorrect or missing
74	X - Other
3	Z - Missing Document - Process Review Incomplete
321	Total Tech. Observations

Figure 2.3.3.

<i>Total Technical Observations Summary Count</i>	
STS:	109
Team - Report Count	All
	<i>Tech. Obs. Type/Code</i>
17	A - MR Rationale incorrect or missing
43	B - Summary/Conclusion incorrect or missing
9	C - System cleanliness level compromised
11	D - System config. could compromise data integrity or accuracy
50	E - System configuration could damage hardware
94	F - Drawing Reqs incorrectly incorporated, incomplete or missing
54	G - OMRSD Reqs incorrectly incorporated, incomplete or missing
162	H - Other specification incorrectly incorporated, incomplete or
16	I - Troubleshooting data analysis incomplete, incorrect or missing
4	J - Troubleshooting leads to incorrect conclusion
9	K - Retest incomplete, incorrect or missing.
85	L - Data recorded not within specified limits
268	M - Paper has open work steps (steps not bought complete)
168	N - Wrong steps worked (NP options incorrectly selected)
110	O - Critical skill requirements incomplete, incorrect or missing
184	X - Other
20	Z - Missing Document - Process Review Incomplete
1304	<i>Total Tech. Observations</i>

Figure 2.3.4.

This review pointed out two weaknesses that NASA/USA must correct. The engineering review of paperwork should have been done, as an aspect of the quality assurance program, all along. More oversight may not be necessary. Current process provides three or more layers over paperwork review prior to being scanned into the database. However, if review authorities in the work section, S&MA, SQ&MA, TAIR, or engineering are not aware of the most common problems to look for corrections cannot be made. Routine sampling will help refine this process and cut the error significantly. Finally, the process of paperwork review must be standardized among the various Space Shuttle systems for both quality assurance functions and engineering. Some of the system engineering offices have processes that sample WADs for accuracy prior to being published. Applying a statistically based process control system for sampling of WADs before and after the fact is highly recommended.

Existing paperwork trail, auditing accountability/traceability system is excellent. The extent of documentation required and the sheer volume of paperwork involved are phenomenal and appear very well managed. The monumental task of cataloguing and preserving Space Shuttle documentation is well organized and commendable.

Proposed Recommendations:

Quality and Engineering review of work documents for STS-114 should be accomplished according to statistical sampling methods, to ensure a representative sample is evaluated and adequate feedback into the process is communicated to resolve documentation problems.

Implement USA's suggested remedial actions for process improvement to include a statistically based recurring sampling (by SQ&MA) of all future paper work to identify recurring problems and implement corrective actions.

Develop a NASA S&MA oversight process to statistically sample the work performed and documented by USA technicians to ensure process control, compliance and consistency with SQ&MA sampling results.

2.4 CAPABILITIES ANALYSIS

Issue:

Do NASA and contractor ground operations managers routinely assess their capability to support workload requirements? Do they have the tools to identify when they are approaching (or exceeding) the "ragged edge"; i.e., the point at which requirements exceed capabilities? At what point does the production/launch schedule become unsupportable without adding resources or delaying milestones? What actions are taken to add resources or slip milestones?

Background:

NASA's resources have been trimmed and processes streamlined in efforts to control/reduce the cost of operations (see Figure 2.4.1). While this has happened in many areas, one of the most obvious examples is the reduction of the combined NASA/USA workforce at Kennedy Space Center (KSC), which totaled over 8,800 in 1991. By 2002, this workforce had been downsized by slightly more than 50 percent to approximately 4,400. Shuttle launches over the same period had decreased disproportionately by only 25 percent, from eight to six. Another example of efforts to improve efficiency and lower costs was the relocation of Orbiter Major Modifications (OMM) from Palmdale, California, to KSC, starting with OV-103 (*Discovery*) in September 2002. Although the last four OMMs at Palmdale had required anywhere from 324 to 448 equivalent personnel, it was estimated that that OMMs could be supported at KSC with only 235 additional equivalent personnel due to more effective utilization of the existing KSC workforce. However, during the first 9 months of OV-103's OMM, an average of 307 EP have been required, a 31 percent overrun of the initial estimate.

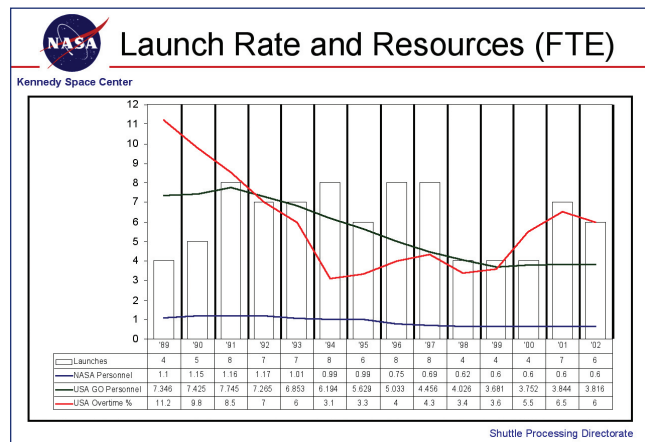

Figure 2.4.1. Space Shuttle launch rate versus Full Time Employee resources.

While the drive toward increased efficiency and controlling costs is commendable, it is vitally important that managers have the tools necessary to determine, as far in advance as possible and preferably during workload planning and scheduling, when resources and capabilities will be exceeded. Such knowledge would allow them to take mitigating

actions well in advance of the forecasted shortfalls. This is particularly critical, given the many opportunities for unforeseen requirements that can result from limited experience operating and maintaining this unique, reusable space vehicle. These unknowns can manifest themselves in many different and valid forms including technical surprises requiring additional, unplanned inspections, maintenance, and modifications. These requirements must be accomplished over and above a production schedule built to balance efficiency with timeliness, and one in which milestone slippages leading to delayed launches are seen as negatives to be avoided as much as possible. These unanticipated requirements almost always equate to more inspections and/or maintenance that, in turn, either drives increased overtime labor or a need to increase the size of the workforce by hiring more employees. Each course of action carries inherent disadvantages. Prolonged use of overtime increases the potential for mistakes and hiring more personnel to perform highly technical, painstakingly meticulous work brings other challenges, such as finding qualified people, training them, and ensuring their lower levels of experience do not cause mistakes.

An example of a technical surprise that drove an unanticipated workload occurred in the aftermath of STS-93 (July 1999), when a short circuit five seconds after *Columbia's* liftoff caused a loss of power to two of the six main engine controller computers. The ensuing investigation determined the root cause to be a damaged wire and led to extensive fleet-wide inspections and modifications, starting with *Columbia* in October 1999, only one month after it began its OMM. None of this additional workload was anticipated, planned, scheduled, or resourced. Compounding the surprise, engineers and planners expected 500 to 700 wiring anomalies, but were shocked by over 4,600 actual discoveries; each and every one of these required engineering evaluation and disposition, and in the majority of cases, correction by maintenance personnel. The vast number of wiring anomalies necessitated revising the inspection “chit” no less than six times in the course of the OMM, further exacerbating the growing workload. The initial workforce resourced to perform *Columbia's* OMM was determined based on the original OMM requirement, which excluded the wiring inspections and modifications. This workforce numbered 342 and had an 85 percent experience level, with experience being defined as either manufacturing the Orbiter or working on a previous OMM. However, as the workload steadily grew, personnel worked longer hours and more personnel had to be hired, increasing the workforce by 46 percent to 500 personnel. This dropped the experience level to approximately 58 percent, which, in turn, drove increased training requirements, including on-the-job training, at the expense of production. Yet another example of a technical surprise during *Columbia's* OMM was the chance discovery of cold plate corrosion.

As the Orbiter fleet ages, technical surprises such as those cited above will also likely continue and may even increase. Additionally, there will be great pressure to return to flight once the *Columbia* accident investigation has concluded. Given these kinds of surprises and production pressures, capabilities assessments will grow increasingly important to safe Shuttle operations.

Findings:

During the May 1, 2003 OV-103 J3 OMDP (Orbiter Maintenance Down Period) Project Management Review (PMR), the Orbiter Processing Facility (OPF) tile technician workload was briefed as a concern. Tile replacement requirements had grown 28 percent over original projections, and tile technician labor requirements had grown by 11.5 percent. Potential additional tile technician labor growth ranged from a low of another seven percent to a high of 24 percent (82,522 to 111,892 labor hours). No mitigating actions were proposed, and the briefing was treated as informational (rather than actionable) at that point.

During the same PMR, the “tile backstop” also briefed similar concerns. Test tile production in support of the *Columbia* Accident Investigation had driven a 473 percent requirements increase, from 128 to 606 tiles, not to mention the previously mentioned higher projections related to *Discovery's* OMM. Tile backshop management offered several mitigation options, including working more overtime, augmenting the workforce with additional manpower, reactivating the Palmdale tile shop to produce test tiles, or bringing skilled tile technicians from Palmdale to KSC on a temporary basis. The approved action was to hire additional personnel, specifically machinists, to open up one of the production bottlenecks.

What’s important in both of these examples is that two production areas were attempting to project their capabilities and assess them against projected/potential requirements.

Discussions with both NASA and USA managers revealed that baselines and templates were being developed for both OMM and down-/up-mission processing; these, in turn would enable better requirements projections. They have also used various capability assessment models over the past several years, such as “equivalent flow” which showed, prior to the *Columbia* tragedy, that the FY2003 and FY2004 launch schedule would drive a workload that would exceed capability by as much as 64 percent. These same managers were adamant that they would do everything in their power to mitigate situations such as this 64 percent overload, to include production/launch schedule slippages. However, they also commented that the launch schedule was driven by direction from the very top levels of NASA, and their launch slippage requests often fell on unreceptive ears.

Conclusions:

As the Orbiter fleet ages, technical surprises will likely continue and may even increase. Additionally, there will be great pressure to return to flight once the *Columbia* Accident Investigation has concluded.

Unanticipated requirements, such as those caused by technical surprises, combined with production pressures, can quickly outstrip resources and capabilities. Under these circumstances, capability assessments that enable mitigating actions as far in advance as possible will grow increasingly important to safe Shuttle operations.

Some work centers have performed capability assessments and used them to advise managers of various options to mitigate existing or potential requirements overload situations. NASA/USA managers have been working with capability assessment models for several years at a macro-level but do not feel they have a tool with sufficient fidelity and confidence to advise when launch (manifest) schedule slippages are necessary.

Proposed Recommendations:

NASA/USA managers should expedite efforts that have been ongoing for several years to develop accurate, credible capability assessment models and use the results to take action as far in advance as possible whenever requirements exceed capabilities.

NASA/USA managers should develop sufficient confidence in capability assessments to use them in manifest (launch) and ground operations resource planning.

References:

1. USA briefing, "OV-103 J3 OMDP Project Management Review," 12 June 03
2. Boeing/Palmdale OMM briefings/tours, 14 May 03
3. USA briefing, "OV-103 J3 OMDP Project Management Review," 1 May 03
4. USA Ground Operations briefing, "Equivalent Flow Model," Apr 03
5. HEDS/IA briefing, "OV-103 J3 OMM Assessment," 14 November 01
6. Boeing report, "OV-102 Wire Inspection Report, September 99 – February 01," Jul 01
7. HEDS/IA report KS-0003, "Evaluation of the Current (OV-102) Orbiter Major Modification (OMM) Flow," Mar 01
8. KSC Shuttle Processing Directorate chart, "Launch Rate and Resources (FTE)," undated
9. USA Ground Operations chart, "Orbiter Power Capability," undated

3.0 FLEET SUSTAINMENT

3.1 SERVICE LIFE EXTENSION PROGRAM (SLEP)

Issue:

Evaluate NASA plans for the SLEP of the Space Shuttle to provide for safe and efficient operations beyond the 2012 timeframe.

Background:

Shuttle Program retirement, until recently, was planned for the early 21st century. Early Program expectations for the service life of the Shuttle system were based on 100 flights per vehicle over a 10-year period. The original certification of some of the structures and subsystems was done to 2 or 2.5 times the life expectancy at that time, specifically 10 years, starting 1981. Some destructive testing was done on partial or subscale structures at the beginning of the program

but follow-on sustainment research has been done at subsystem level primarily. The Orbiter was originally designed for a minimum of 10 years useful age life; i.e., static age life plus operating life (100 missions); static life is defined as storage life plus installed life in a non-operating mode in an ambient environment. In preparation for return to flight (RTF) following *Challenger*, it was recognized that some materials were already in excess of 10 years static age life. This led to concerted efforts by Materials and Processes and Design Engineers to identify age/life problems. In 1987, a review of 330 non-metallic materials used in the Payload Integration Hardware program (324 common to the Orbiter) was done; 291 were extended to 20 years; 38 were deemed "probably" acceptable for 20 years, but lacked sufficient data, with the recommendation of periodic inspection; one remained limited to 10 years.³²

In preparation for STS-26 (September 29, 1988), approximately 2,500 Orbiter parts that exceeded 10 years of life, were assessed by their respective subsystem design groups using the results of the above referenced non-metallic materials assessment. These subgroups reached the conclusion that there were no age life concerns in the program at that time. For STS-29, STS-30, and STS-28, similar assessments were performed for the "delta" items; i.e., new items exceeding 10 years. Based on the absence of age/life concerns in four consecutive pre-launch reviews and the "inherent stability of nonmetallic materials,"³³ NASA and Rockwell agreed in May 1989 to discontinue flight-by-flight assessments relying on CoFR processes to validate aging issues when surfaced by the subsystem managers. This historical approach to extend the 10-year certification to 20-years, while including materials and subsystems assessments, fell short in integrating these efforts at an overall Space Shuttle Program level. Apparently individual materials and components were requalified, rather than an overall systems approach to recertifying the Shuttle system. The recertification that was done to extend the Shuttle fleet beyond ten years was a rudimentary tabletop drill and review of subsystems and materials. While this drill resulted in the identification of some obsolescence issues and created some preventative maintenance programs, it lacked the rigor necessary to predictively build longer-term sustainment programs or extend the Shuttle system beyond the second 10 years.

The Integrated Space Transportation Plan states a requirement for the Space Shuttle "through the middle of the next decade and possibly beyond." Consequently, the SLEP program was initiated by Headquarters Code M in December 2002 and established at Johnson Space Center under the Space Shuttle Program Development Office. The SLEP office consists of four people. DAA-SSP/ISS set the program goal for sustainment at 2022 to accommodate the budget cycle. Their mission is to identify the investments required to fly the Space Shuttle safely and effectively through 2022 and then build a budget requirement timeline to support this plan. This new office has built a straw man budget plan through the out years with funding lines for four different prioritized categories: Should Do, Current Commitments, Foundational Activities, and Projects and Studies. Program development is still in the seminal stages and program definition, including lines of responsibility, is stated in broad terms.

Findings:

The overall goal of the Service Life Extension Program is to identify, prioritize and advocate programs that will extend the service life of the Orbiter vehicle and associated Shuttle systems. Several goals have been expressed within NASA for the programmed life extension of the Shuttle ranging from “middle of the next decade” to 2020, 2022 and as long as 2030.³⁴ Definitive planning needs a target date to set its course. In the absence of a target date, the Shuttle Program Office is unofficially using the 2022 date as a planning horizon but is not limiting itself to that specific date. NASA should identify a target date to base SLEP plans on and, eventually, budget support.

Development of a prioritized list of SLEP championed projects has been done using an Analytical Hierarchy Process (AHP) tool that will help compare dissimilar projects on the basis of total impact to service life extension as well as safety, urgency, and cost. (See Figure 3.1.1) A team of eight program managers developed the weights for the AHP to evaluate and define sustainment projects. The Shuttle Program Manager approved their recommendations with some adjustment to add weight to safety related issues. The “Should Start” priority items are defined as sustainment projects that must be initiated in FY2004 due to an urgent requirement such as Diminishing Manufacturing Source (DMS) or obsolescence. Examples include sustaining test equipment tasks for SSME and case hardware availability for RSRM. Priority 2, “Current Commitments,” includes projects that are already committed to a budget timeline. Examples include the Cockpit Avionics Upgrade, SSME Advanced Health Management System (phase 1), infrastructure, and Industrial Engineering for Safety. Priority 3 “Foundational Activities” includes Aging vehicle studies, Mid-Life Certification and NDE upgrades. Priority 4, “Proj-

ects and Studies,” includes obsolescence issues and vehicle health monitoring. This matrix is employed to derive the priority for candidate SLEP programs.³⁵

The methodology used to begin populating the SLEP candidate list was a simple data call to all Space Shuttle project, system, and subsystem managers. During the March 19-20, 2003 SLEP conference this list grew to over 100 candidates ranging from direct Shuttle serviceability impacts to industrial safety and infrastructure. The well-defined projects were run through the AHP algorithm yielding a prioritized list. This list was then built into a straw-man budget plan. Figures 3.1.2 and 3.1.3 show the budget plan by year and project.³⁶

The SSP SLEP is in the infancy stages of requirements development and needs some definitive bounds. It currently includes classic sustainment of aging aircraft projects in the same priority analysis with safety (ground and flight), infrastructure (tooling, buildings and equipment), capability upgrades, and basic research projects for the program, not necessarily limited to Shuttle service life. Funding lines for classic sustainment issues (such as obsolescence and tasks revealed by the mid-life recertification process) are limited to the next two years due to the lack of project definition beyond FY2005. Under normal federal financial and budgeting processes this lack of definitive bounds may leave the SLEP open to budget cuts and priority confusion resulting in selection of non-direct sustainment projects and dilution of NASA’s ability to resolve sustainment issues.

At this stage in the program’s development there does not appear to be much reliance on the existing databases, such as PRACA, that could be used to help identify SLEP opportunities as individual subsystem project management. The first summit meeting held last March resulted in a list of over 100 new project recommendations collected from the

	A. Sustainability	B. Safety Improvement	C. Efficiency Improvement	D. Customer Driven Capability
1. Should Start	<ul style="list-style-type: none"> • RSRM Case Vendor • PRSD Tank Vendor • SSME STE Equipment 			
2. Existing Commitments	<ul style="list-style-type: none"> • LLAFC • Infrastructure 	<ul style="list-style-type: none"> • Cockpit Avionics • AHMS I • MLG Tire/wheel • Industrial Safety 		
3. Foundational Activities	<ul style="list-style-type: none"> • Aging Vehicle • Mid Life Cert • Fleet Leader • Corrosion Ctrl... • RSRM Ground Test • Sustain Health 	<ul style="list-style-type: none"> • PRA Development 		<ul style="list-style-type: none"> • Performance Trades • Lift • Power • Stay Time • SS Utilization Reinvent
4. Projects and Studies	<ul style="list-style-type: none"> • Vehicle Hlth Mon. • STE Obsolesc • Material obsolesc • Component obsolesc • Supply Chain Viability • Spares Augment 	<ul style="list-style-type: none"> • New Start: AHMS II • Study: Hydrazine • Study: SSME Nozzle • Study: Orbiter Hardening • Study: Enhanced C/W • Study: Crew Surviv 		

Figure 3.1.1. SLEP prioritization structure.

various program/project managers. This is encouraging in that it indicates broad acceptance of the program; however, it also indicates that there isn't much rigor in the qualification process.

The Mid-Life Certification (MLC) is a necessary process that will require NASA and Shuttle Program managers to review all the basic vehicle design and certification criteria and revalidate them. This recertification will uncover design and manufacturing assumptions that were made using the limited 10-year/100-launch life span of the system. Shuttle Program management has delegated the development of MLC to the individual elements and subsystem managers. Approximately 80 percent of the effort will reside in the Orbiter itself. The Orbiter element is beginning its MLC program development using a three-step process, an expanded Certification of Flight Readiness (called CoFR Plus), certification verification, and certification extension.

CoFR Plus is the first step for Orbiter return to fly as well as MLC. This more rigorous certification will begin in summer 2003 in preparation for the anticipated first flight after *Columbia*. In addition to the normal subsystem-by-subsystem review of flight certification, reported up-channel to the program management, the Orbiter MLC office wants to add a horizontal check to verify certification between subsystems. Essentially, they want to look at known problem areas in one system and determine if there's a risk to other systems. An example of this horizontal review is the integrated approach used to alert other systems of the problem with the flex hoses. This will facilitate an integrated approach to certification of all the subsystems as part of the overall system as well as their interaction. The intent is to integrate this process improvement into all future certifications.

The Space Shuttle Program's extended life raises several questions about the vehicle and component's original certification. The verification of certification step is envisioned to be a review of the CoFR process with intent to verify that the program is reviewing the right areas, prior to flight approval, with regard to the current operating environment (as compared to the anticipated operating environment in the late 1970s). The long-term exposure to salt air and the high wear induced by maintenance are two examples of environments that the original certification did not anticipate. The flex hoses, mentioned previously, failed under low frequency vibration induced stress that was not anticipated in the original certification. This MLC process is expected to be a one-time review. The Orbiter Project is planning to complete this verification for all CRIT 1.1 systems in time for the next CoFR. The remaining CRIT systems will be accomplished thereafter.

The extension of the SSP certification beyond 2020 is the final step. This data intensive process will include a review of the NASA and contractors' databases with intent to identify all the original certification criteria and assumptions that may not be valid today. Their intent is to do this archival review as well as current trend analysis using UA, PRACA, CARS data, and other relevant databases. This information will then be used to build new certification criteria and maintenance or modification programs to sustain the Shuttle Pro-

gram. Additionally, this review will build a database to be used in future certifications and provide training for younger engineers in the program invaluable experience relating to system certification processes. The extension program will be designed as a one-time review as well.

The MLC is currently ranked in the third tier of SLEP projects, at the top of a list of undefined projects. This list, which includes Mid-Life Certification, Fleet Leader, and Corrosion Control, are the core of a service life extension for this system. Funds to start MLC are programmed to begin in 2004 and include adding 50 to 100 additional personnel to get this program started. The MLC is expected to increase certification confidence and build a sustainment program complete with maintenance, inspection, and modifications that will extend the life of the Shuttle Program. The key to success will be in its funding and rigor as the program office integrates the various systems toward one goal.

The Shuttle's next certification and the SLEP program should be founded on the basis of a thorough Mid-Life Certification. The SLEP management recognized this problem at the May 2003 program review: "We need a focused effort to move these activities from the undefinitized to the definitized portion of the budget. Progress should be targeted to support the 2004 Summit."³⁷ The Orbiter Program is starting out with some outstanding ideas on how to organize this tremendous MLC task. The Program Office should standardize the approach between the systems to ensure rigor and accuracy of the final product. NASA has most of the necessary ingredients for a successful sustainment program for the Shuttle Program. The only impediment to building it is a centrally organized sustainment office with authority to integrate the various Space Shuttle systems and sites.

NASA Langley was invited to brief the Board on the status of their research in the area of aging aircraft on May 12, 2003. Their briefing included information on the various structures, crack growth predictive techniques and non-destructive examination techniques. The briefing ended with their recommendations for a service life extension program that will help identify the projects for the Shuttle fleet:

NASA Langley has learned critical lessons from the aging aircraft commercial and military fleet experiences:

- Update the design flight loads spectrum.
- Update the original durability and damage tolerance analyses and include environmental effects.
- Search for the emergence of new fracture critical structure.
- Evaluate the necessity for a new full-scale fatigue test to support the life extension goal.³⁸

Proposed Recommendations:

NASA needs to identify a definitive target date for SLEP planning. The current goal(s) leaves confusion and may not result in an adequate solution set.

Build a Space Shuttle Program sustainment office with authority to integrate between systems.

NASA needs to more restrictively define the SLEP mission. The current construct apparently establishes this program as the central repository for nearly any Shuttle and age/life related project. The result of this loose mission definition will more likely be budget cuts and priority confusion resulting in selection of non-direct sustainment projects and dilution of NASA's ability to resolve sustainment issues. NASA

must restrict this program's mission to direct sustainment of the Space Shuttle Program and its associated infrastructure.

NASA should build this program, first, on the basis of a rigorous and comprehensive mid-life recertification of the SSP and second, on the data collected through OMDP and aging aircraft studies that should identify the priority areas

	FY03	FY04	FY05	FY06	FY07	FY08	FY09	Total FY04-FY08
Total POP 03 SLEP Recommendation	28	41	42	347	24	23	21	1,668
1 Should Start In Fiscal Year 2004	0	15	16	14	9	13	13	66
RSRM - Case Hardware	0	5	5	5	5	5	5	25
Orbiter - Certify PRSD Tank	0	4	8	8	4	8	8	31
Supplier & Procure Spares								
SSME - Sustaining Test	0	6	3	1	0	0	0	10
2 Commitment	26	27	23	156	13	12	12	926
Vehicle Cockpit Avionics	8	9	7	1	0	0	0	182
Vehicle Main Landing Gear Tire & SSME Adv'd Health Mgmt System (AHMS Phase 1)	3	3	0	0	0	0	0	3
Industrial Engineering for RSRM	8	4	3	2	1	0	0	10
Infrastruct	8	1	1	1	1	1	1	75
Other	1	1	1	2	2	2	2	98
	9	9	7	7	7	8	8	406
	5	5	4	2	2	1	8	152
3 Foundational	3	23	31	23	12	24	12	113
Aging Vehicle	2	1	1					24
Mid-Life Certification Assessment & Issue Mitigation								
Fleet Leader								
Corrosion								
STE Survey /								
Non-Destructive Evaluation Upgrades								
Ground Test	0	4	1	2	9	2	9	64
Performance Trade Studies / Lift, Improved Tools /	1	2	2					4
Probabilistic Risk Assessment	1	7	5	3	3	3	3	21
Sustainability Health Metrics								
Analytical Hierarchy Tool System								

<i>Real Year Dollars in Millions - Not in Full Cost</i>								Total
	FY03	FY04	FY05	FY06	FY07	FY08	FY09	FY04-FY08
4a Sustainability	2	40	62	73	47	38	40	259
New Start: Vehicle Health	1	4	4					8
New Start: ET 3rd Generation	0	3	7	8				
STE Obsolescence	1	1	1	1	7	7	5	59
Material	0	2						2
Component	0	6	2	2	1	1	9	85
Supply Chain	0	4	0	1	1			5
Spares Augmentation for	0	5	1	2	2	1	2	82
4 Improvement	16	45	62	62	23	12	5	204
New Start: SSME Adv'd Health Mgmt System Phase 2b	7	3	4	4	2	1	5	160
Study: Hydrazine	3	3	3	1				7
Study: Orbiter	2	2	2					4
Study: SSME Channel Wall	3	4	1	1				32
Study: Orbiter Enhanced Caution and Study: Crew Survivability	1	1						1
4c New Capabilities	0	0	0	0	0	0	0	0
Reserves	0	20	20	20	20	20	20	100

Figures 3.1.2 and 3.1.3. SLEP Budget Plan.

of concern for this aging system. This MLC should be thorough enough to build a sustainment plan based on analytical condition inspections, service extending modifications and maintenance and inspection programs to keep close vigilance of aging systems and component structures.

Finally, NASA Shuttle Program management should significantly accelerate plans for the Mid-Life Certification in advance of the 2004-2005 study period and rank it highest in the SLEP hierarchy.

3.2 SUSTAINMENT OF AGING NASA INFRASTRUCTURE

Issue:

Assess aging NASA infrastructure (facilities and equipment), to include planning and programming of sustainment/replacement actions.

Background:

Much of NASA's infrastructure was built in two eras: the Apollo era of the 1960s and the Space Shuttle era of the mid- to late-1970s. In many cases, the forecasted life of the program was not much more than 10 years, and facilities and equipment have been rehabilitated or modified numerous times to keep them "launch ready" as the program was "extended to the right." Primary focus has been on infrastructure deemed critical to the mission, such as launch pads and crawler-transporters (CT). The further removed from the immediate mission, the less the attention it received, explaining the lack of shelters for ground support equipment. Infrastructure funding has varied in parallel with expectations of how much longer the Space Shuttle Program (SSP) would continue; in the mid-1990s, it could have been characterized as "life support until imminent retirement," which later changed to "sustainment until 2020" after the X-33 program was terminated. By the time SSP managers received guidance to invest in infrastructure due to the X-33's demise, construction of facility (CoF) and facility maintenance budgets had already been consistently reduced for six years, from 1994 to 1999. This was the result of heavy NASA budget cuts, starting in 1994 and resulting in a strategy to absorb many of the reductions from infrastructure. Much of today's "bow wave" or "catch up" is the result of these years of under-funding in particular, and overall short budgets in general. Finally, at Kennedy Space Center, keeping the infrastructure in serviceable condition is problematized by one of the most corrosive environments known: a combination of the highly corrosive natural environment along the Atlantic Ocean and acidic deposits from the Solid Rocket Motor (SRM) exhaust.

FINDINGS:

Following are three examples of a deteriorating infrastructure.

Example 1: KSC launch pads 39A and 39B are continual challenges to maintain in launch ready condition due to corrosion and the forces associated with launches. The original

structure, which serves as the core of the Fixed Service Structure (FSS), was designed and built in the Apollo era and incorporates older designs which trap fluids, including corrosives, even after post-launch wash downs, as well as precipitation. To their credit, ground systems support personnel and engineers recognized these design problems a long time ago, and newer modifications/replacements, such as the Rotating Service Structure (RSS), are better designed, without fluid traps. As the pads have aged and modifications/upgrades have been incorporated, many of the older systems have been abandoned in place; there is evidence of old clamps, conduits, mounting brackets, and other hardware that continue to corrode. This can be problematic, as continued degradation of these abandoned systems can contribute to loose debris during launch, posing a hazard to the shuttle. Again, to the ground support systems management's credit, they have recognized this and have lobbied for/received funding to remove formerly abandoned-in-place hardware; while much has been done, much remains and efforts are continuing. On each pad's RSS, the Payload Changeout Room's walls of foam core sandwich construction are deteriorating due to acoustic loads during launch. While repairs have been accomplished using a multitude of through-bolts, these are at best temporary and add needless weight to the movable structure. A more permanent repair will require serious consideration of an alternative design to ensure durability. There is also extensive concrete deterioration at the pad base and blast deflector areas; these are repaired from launch to launch. KSC has 83 railroad boxcars at pads 39A and 39B. These were procured for their durability and are used as offices and work centers for support personnel. Unfortunately, they are extensively corroded and ceiling leaks/buckled floors can be seen in various locations. To KSC's credit, they are correcting this situation with the construction of new facilities at each launch pad that will completely replace the boxcars; move-in is scheduled for FY2003.



Figure 3.2.1. Launch Pad Corrosion and Boxcar Facilities.

Past upgrades of wiring in the Pad Terminal Control Room are another example of attention to the sustainment of a launch critical system, with a progressive approach incorporating modernization as demanded by system requirements. One specific area requiring attention is the theory (suggested in the early- to mid-1990s) that the lack of top-coating over inorganic zinc primer on launch pad areas was leading to zinc leaching through rainwater runoff onto Orbiter wing

leading edges; this, in turn, was causing the formation of pinholes in the RCC panels and possibly decreasing the service life of these critical Orbiter components. Launch pad rain sampling in 1994 confirmed zinc oxide contamination. Despite improved corrosion control management and execution since then, follow-on rain sampling in July 2003 showed that zinc oxide contamination persists and illustrates how infrastructure maintenance can have a direct impact, not just on immediate Shuttle operations, but also on service life. NASA Standard 5008, “Protective Coating of Carbon Steel, Stainless Steel, and Aluminum on Launch Structures, Facilities, and Ground Support Equipment” “requires a top-coating on all new and repaired surfaces, with the exception of Mobile Launch Platform (MLP) 0-level deck surfaces and lower levels of the FSS (95- and 75-foot levels), as these are in the direct blast impingement area during liftoff. Despite these requirements, launch pad corrosion control measures need to be examined with the objective of further reducing or completely eliminating zinc fallout.

Example 2: The Vehicle Assembly Building (VAB) is the only facility of its kind in the world and a critical element of the Space Shuttle Program. It is where the Orbiter, External Tank, and Solid Rocket Boosters are mated and demated. It was constructed in the 1960s for Saturn V buildup. Like the launch pads, it serves as an example of both the problems faced by the SSP and NASA in maintaining aging infrastructure, as well as ongoing efforts to meet these challenges. The 5-acres of roof from its original 1964 construction are comprised of 6 inches of foam and vinyl layers added over the concrete slab through the years. Regular repairs are accomplished on the roof’s outer surface using sealant and asphalt paper. Roof leaks over the years have led to deterioration (spalling) of the concrete ceiling on the interior of the roof slab, with concrete fragments occasionally falling loose from a height of over 500 feet. This FOD hazard has been mitigated by the installation of a subdeck five feet below the ceiling to catch debris and safety nets at lower levels. A comprehensive repair effort has been funded for FY2004 to remove all roof outer layers down to the original slab and recover with sloped roofing boards and a synthetic membrane, as well as repairs to the interior concrete ceiling. Significant portions of the VAB’s 1.1 million square feet of siding also require repair due to corrosion; this is especially critical due exposure of this vast surface area to hurricane-force

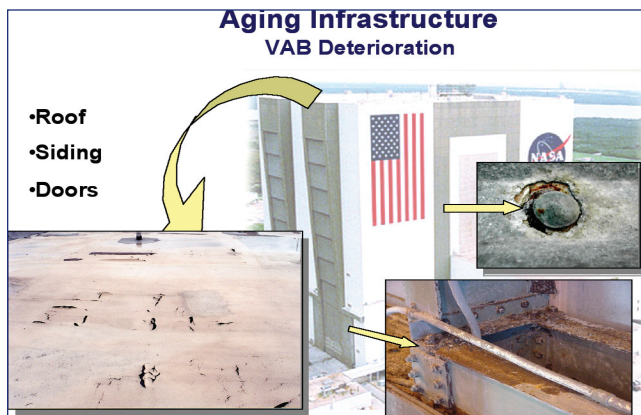

Figure 3.2.2. Vehicle Assembly Building.

winds; repairs are scheduled for FY2006. Several of the VAB’s massive multi-panel doors require extensive corrosion repair. The structure’s overhead bridge cranes are a mix of 1960s and 1990s vintage equipment, but are effectively sustained through regular maintenance due to their critical role in mating/demating operations.

Example 3: Two of the Shuttle Program’s most critical pieces of equipment, the Crawler/Transporter (CT) systems, pose a significant technical sustainment challenge. (See Figure 3.2.3) These unique vehicles are necessary to move the stacked Space Shuttle to and from the launch pads. During hurricane season – roughly half of the year starting in early summer – both must be up and running in the event Shuttles must be moved from the pad back to the VAB for “safe haven.” This precludes extensive maintenance during this entire period. Built in 1965, the CTs each average over 1,700 miles. They have received incremental capability upgrades over the years, including a laser docking system, computerized control stations, and replacement control cabs. The massive hydraulic actuators used to jack, level, and carry the Mobile Launch Platform (MLP) and Shuttle Stack were recently refurbished for the first time. Obsolescence of purpose-built components poses a major challenge, and will continue to need correction through upgrades. Corrosion is a significant problem due to no sheltered storage, and maintenance is frequently suspended due to severe weather. As support costs rise due to aging and obsolescence, it was noted that managers track resources expended (costs of modifications/parts/labor) over time, but do not do so per unit of output (miles driven or operating hours). While costs over time will always increase, a more valuable metric is cost per unit of output, as this can be used for analysis and trending and can help in more clearly comparing the cost/benefit tradeoffs of inaction, modification, or replacement.



Figure 3.2.3. Crawler Transporter (CT).

Benchmarking With Industry/Adopting Best Practices at KSC

The GSS contractor has implemented an effective program to manage its facilities’ corrosion problems. In 1995, Lockheed Space Operations (now part of USA) contracted Corpro (formerly Consulex) to develop a comprehensive software package to gather, archive and present a wide range of data concerning assessment, programming and execution of the facility corrosion control program. Corpro took a tool developed for the offshore oil industry and adapted it to KSC. The system, known as Basecoat, is in its third year of use. (See Figure 3.2.4) It integrates the corrosion protection

requirement, type of material, estimated cost, photos and video of actual structure for condition trending, life cycle costing, and so forth. Efficiencies realized by this software enable all facility condition data to be gathered by two inspectors, as opposed to the former method of file cabinets populated with files of paper that were labor-intensive to compile, review, trend, and prioritize. Basecoat can be efficiently used to prioritize requirements, determine/program budget requests, and schedule maintenance. It also has the ability to divide structures, such as the launch pads, into subcategories (levels) and components on each level; this, in turn, enables prioritization at the subcategory or component levels if resources (such as money or system availability) are not available for the entire system. Another feature identifies “hot spots” where multiple problem areas cluster together, and rank orders them according to criticality for immediate programming. This exceptionally effective package is worthy of benchmarking.

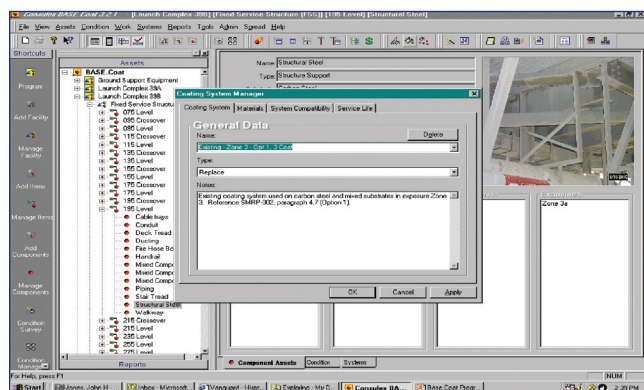

Figure 3.2.4. CorrPro Basecoat Software Example.

KSC Facility Sustainment Management

NASA’s Facility Project Budget and Management strategy has undergone several major changes over the past decade. Prior to 1994, a single Construction of Facilities (CoF) appropriation for NASA was allocated; in 1994, the process was changed, with CoF funds now appropriated per program. The annual budget development and coordination process involves both the contractor and KSC management in requirements determination, with the budget forwarded through NASA hierarchy. Development of programs to replace and refurbish systems is accomplished by the Ground Systems Working Team (GSWT). The GSWT is jointly staffed by USA, Shuttle Gateway Services (SGS), and NASA personnel and uses a risk assessment process to prioritize requirements.

The portion of SFOC pertaining to infrastructure maintenance (generically falls under “ground operations”) includes a cost savings incentive for cost under run: NASA gets 65 percent, USA 35 percent of savings. NASA retains its provisioning role under SFOC, including Construction of Facilities (CoF). USA is an active participant in the requirements development process. The Facility Management Plan is a contract deliverable, under SFOC contract DRD 1.5.5.2, and includes the long range plan, annual work plan, preven-

tive maintenance, predictive test and inspection, corrective/programmed maintenance, backlog of maintenance and repair (BMAR), and facility condition assessment program (FCAP). The Facility and Equipment Maintenance Plan, Part II - KSC Ground Operations, is a contract deliverable, under SFOC contract DRD 1.5.5.2, and includes an annual submittal of metrics reflecting Facility/System Availability During Operations, Condition Assessment Program, CM/Total Maintenance Ratio, and Actual Cost Trends by General Classification. According to a senior manager, “The three hardest aspects of our job are getting the funding, the resources, and the proper window in the operations schedule to line up. Based on my 30 years experience, infrastructure support has always been budget-driven, not requirements-driven.”

Recently, in efforts to better align the “windows” of opportunity mentioned above, USA has established master planner positions for GSS (fall 2002) and Orbiter horizontal processing (early 2003). These two personnel coordinate on a regular basis with the vertical processing master planner to better synchronize their respective schedules. The expectations are, through better synchronization of schedules, windows of opportunity can be maximized and more GSS maintenance can be performed with existing resources; another benefit will be fewer work time deviations and violations.

The most significant finding is that these program metrics only reflect performance with respect to contract deliverables. Until recently, USA has not tracked maintenance hours or materiel expenditures required to achieve program performance objectives. As a result, this limited management perspective compromises NASA’s and USA’s ability to properly characterize the magnitude of deteriorating infrastructure and equipment, limiting their ability to substantiate the requirement to NASA Headquarters and Congress

Management personnel involved in infrastructure support were reluctant to make the case that they are under funded. They maintained the opinion that they typically get enough to “get by” with no mission jeopardy. If no one is tracking resources expended to keep infrastructure in adequate condition (such as operating hours for the crawler-transporter), then management is unable to make fact-based assessments of when support costs are reaching unacceptable levels and when alternate/replacement actions should be programmed.

Michoud Assembly Facility (MAF)

MAF, which falls under the Marshall Space Flight Center (MSFC), is a government owned, contractor operated facility (GOCO). Some of its infrastructure dates back to the 1940s, with add-ons for Apollo and the Space Shuttle. It is where the ET is built and shipped by barge to KSC. Compared with KSC, it is a much smaller installation, has the advantage of being more single-mission focused, and has a much less corrosive environment. Starting in 1997, MAF managers developed all infrastructure and equipment requirements into comprehensive, 15-year strategic plans that address every requirement in a “big picture” context. MAF has been successful in assessing, prioritizing, and articulating their infrastructure requirements, in large part due

to this disciplined, structured approach. The result has been funding support: CoF funding has increased by 371 percent from FY1997 to FY2003 (\$7.9 million to \$37.2 million). Successful projects include the repair of a 43-acre roof over their Main Manufacturing Building and upgrade of their 1940s-vintage 480 volt electrical system. MAF's 15-year facilities and equipment strategic plans are a benchmark practice for all of NASA.

Stennis Space Center (SSC)

SSC, as the National Space Transportation Laboratory, was built during the mid-1960s as part of the Apollo ramp up. Its primary mission is liquid fueled rocket engine testing, including the Shuttle's main engines. Every engine must be tested here after modification and/or overhaul. It has three tests stands, designated A1, A2, and B1/2, which, like much of NASA's infrastructure, are considered national assets. The A1 stand is the only one capable of testing gimbaling. However, it is also scheduled to be mothballed in FY2003 based on no known future requirements. The retirement of the A1 test stand will help conserve scarce infrastructure funding and allow it to be applied elsewhere, as long as the assessment of no future need remains valid.

Boeing/Palmdale (Air Force Plant 42)

These facilities are leased by NASA from the Air Force and appeared in good condition due to the dry, non-corrosive environment. Equipment degradation was evident, primarily due to the recent decrease of Shuttle support.

The NASA "Big Picture"

It is important to examine all of the foregoing observations in the context of the overall NASA program, managed by Code JX at Headquarters. NASA owns over 2,600 buildings and an equally large number of other major structures with

an average age of nearly 40 years. The current replacement value of this infrastructure is \$21.9 billion; for Code M is just over \$10 billion. NASA's current replacement value is approximately 40 percent higher than the Department of Defense's and reflects the unique, specialized nature of many NASA facilities, such as the VAB and launch pads.

A NASA-wide infrastructure assessment was conducted in FY2002 to address the growing Backlog of Maintenance and Repair (BMAR), estimated at \$1 billion. The steady BMAR increase and concern over its safety implications were addressed in the Aerospace Safety Advisory Panel's 2002 report, as well as prior reports. However, because previous BMAR assessments were not consistent or auditable, difficult to "roll up," and were subject to "spin," the FY2002 assessment established a new category designated Deferred Maintenance (DM) and set clear guidelines to be applied consistently across NASA. The result: DM totaled over \$2 billion, double the previously assessed BMAR, primarily because it took into account all facilities, but there is greater fidelity in this figure. This \$2 billion DM figure represents 10 percent of NASA's CRV (an industry rule of thumb is for annual spending of two to four percent of CRV); this high percentage reflects the unique nature and small numbers of much of NASA's infrastructure which, in turn, leads to a "must fix" approach in many cases, as well as a need to catch up due to years of under funding. What's important is Code JX now has a consistent, NASA-wide DM database and is working to apply it to future planning and programming of infrastructure requirements.

Simultaneous with the DM assessment, another "yardstick" known as the Facility Condition Index (FCI) was applied across NASA. Under FCI, facility condition was assessed on a five-point scale, with five being "excellent" and one being "bad." The average FCI was 3.6; for Code M, 3.5; for JSC, 3.6; for KSC, 3.3; for MSFC, 3.9; for SSC, 3.1. Figure 3.2.5 shows the relative FCIs of each center. These FCIs

NASA Sites	Total CRV (\$B)	Total '01 BMAR (\$B)	Total '02 DM (\$B)	Total FCI (Wgt'd)	Active Facilities '02 DM (\$B)	Active Facilities FCI (Avg)	Inactive Facilities '02 DM (\$B)	Inactive Facilities FCI (Avg)
Ames Research Center Total	3.48	0.07	0.23	3.8	0.14	3.3	0.09	2.9
Dryden Flight Research Center Total	0.26	0.01	0.01	4.1	0.01	3.2	na	na
Glenn Research Center Total	2.44	0.05	0.27	3.6	0.14	3.6	0.13	2.5
Langley Research Center Total	2.55	0.03	0.29	3.7	0.24	3.4	0.04	2.2
Code R (Aerospace Technology)	8.73	0.16	0.80	3.7	0.53	3.4	0.27	2.3
Goddard Space Flight Center Total	1.55	0.18	0.10	3.9	0.06	3.7	0.03	1.7
Code Y (Earth Science)	1.55	0.18	0.10	3.9	0.06	3.7	0.03	1.7
Jet Propulsion Laboratory Total	1.01	0.03	0.05	4.1	0.05	3.8	0.01	3.3
Code S (Astrobiology and Space Research/Science)	1.01	0.03	0.05	4.1	0.05	3.8	0.01	3.3
Johnson Space Center Total	1.71	0.20	0.12	3.6	0.12	3.6	0.00	1.0
Kennedy Space Center Total	4.36	0.08	0.51	3.3	0.48	3.8	0.03	2.4
Marshall Space Flight Center Total	2.45	0.23	0.17	3.9	0.13	3.9	0.05	3.4
Stennis Space Center Total	1.57	0.08	0.28	3.1	0.28	3.6	0.00	1.9
Code M (Human Exploration and Development of Space)	10.09	0.59	1.08	3.5	1.00	3.7	0.08	2.5
NASA Total (\$B)	21.4	.95	2.03	3.6	1.64	3.6	0.39	2.5

Figure 3.2.5. Comparison of NASA Sites.

“peel back” to individual assessment areas such as structure, roof, exterior, interior, electric, plumbing, and equipment, and assign varying weights to each area depending on the primary function of the facility. KSC’s lower overall rating reflects the large amount of infrastructure dedicated to the Space Shuttle Program, as well as to its harsh environment. Center ratings can be skewed depending on the value of certain infrastructure relative to the total value; for example, SSC’s rating of 3.1 is based on their engine test stands’ rating of 2.2; since these stands make up 37 percent of SSC’s total CRV, their removal from the overall FCI raises it to 3.6. The NASA goal is to improve the overall average FCI to 4.2 by FY2009, which requires an annual investment of \$312 million.

In efforts to assess the impact of infrastructure investment, Code JX has adopted DoD’s Facility Sustainment Model (FSM) and is refining it for NASA use. This tool estimates the amount of maintenance investment required as a percentage of CRV. For example, NASA has determined that \$333 million of annual facility maintenance funding is required to arrest deterioration. By contrast, \$224M (actual), or 67 percent, was spent in FY2002, and in FY2005, \$273 million, or 82 percent, is planned. Based on past and current funding, NASA’s Facility Revitalization Rate (FRR), or the rate at which a facility will be replaced or revitalized based on funding, is slightly over 100 years. This is down from a high exceeding 200 years, but is still far from the DoD goal of 67 years and the industry goal of 55 years. NASA has determined it can reach the DoD goal of 67 years by FY2009 based on an annual investment of \$302M over five years. Figure 3.2.6 shows past and targeted NASA FRRs. This amount can be reduced by reducing infrastructure, such as the retirement of the A1 test stand at SSC.

NASA has outlined its road ahead for infrastructure improvement. It includes identifying and disposing of excess facilities, making better use of existing facilities through consolidations, and sustaining remaining infrastructure by reducing BMAR/DM (which, in turn, will lower the revitalization rate from over 100 years toward the DoD goal of 67

years), advocating “repair by replacement” where it makes sense, and successfully securing funding support.

A 1996 GAO audit cited NASA problems identifying, assessing, and implementing infrastructure cost reduction opportunities. Initiatives such as last year’s NASA-wide DM and FCI assessments, combined with determinations of facility maintenance and revitalization requirements, indicate a much improved, structured approach to addressing infrastructure from a NASA-wide perspective. While many of these initiatives are in their infancy, this further development will increase the level of fidelity in stated requirements and hopefully result in improved infrastructure funding.

Proposed Recommendations:

While there is a need for much “catch up” funding in Space Shuttle-related infrastructure, NASA’s structured approach to assess the entire organization using a uniform assessment scale is the right approach. This structured methodology, coupled with a long-term view of each facility’s role – such as that taken by Michoud in their 15-year strategic planning – is a sound path to assessing and prioritizing funding requirements. Michoud’s 15-year strategic plans, both for infrastructure and equipment, should be benchmarks for all of NASA; these plans examine and prioritize requirements in a larger, longer term context compared to the five-year Program Operating Plan and are part of the reason for their funding success. Infrastructure requirements can also be reduced by consolidating facilities, or by retiring unnecessary or redundant facilities such as the A1 engine test stand at Stennis; the practice of identifying opportunities for consolidations and retirements needs to continue.

At the tactical level, KSC’s approach toward better schedule integration through the recent establishment of master planners for horizontal and GSS operations holds great promise. Their adoption of commercial practices, such as CorrPro’s Basecoat database, is also highly noteworthy, and they should explore further application beyond corrosion. KSC should do a cost/benefit analysis of building additional shel-

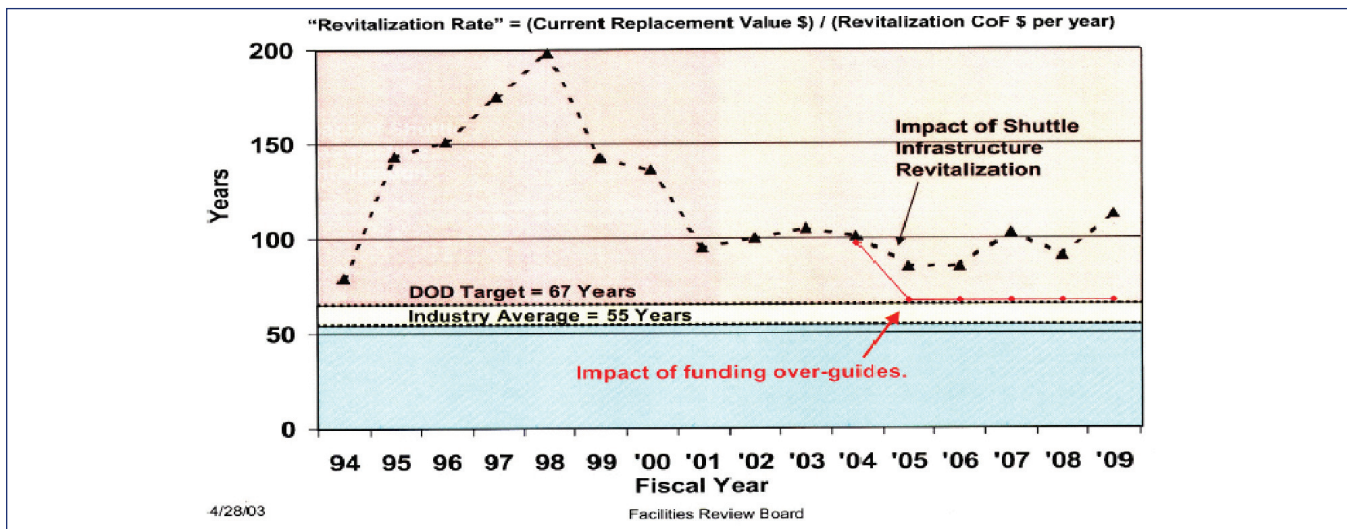

Figure 3.2.6. NASA Facility Revitalization Rates.

ters for its ground support equipment, much of which is left outdoors. They should also perform trending and analysis of infrastructure/ equipment support costs factored over unit of output wherever possible, rather than simply tracking costs, as rate comparisons will facilitate tradeoff/investment decisions. Finally, KSC should examine current launch pad maintenance practices and make every effort to reduce or, better yet, eliminate zinc fallout.

References:

1. NASA report KSC-5600-6256, "Launch Pad Zinc Sampling at LC-39B," June 03
2. Michoud Assembly Facility "Infrastructure Overview" briefing, May 03
3. Michoud Assembly Facility "External Tank Tooling Overview" briefing, May 03
4. NASA "Facilities Review Board/POP-03" briefing, 29 Apr 03
5. "CAIB VAB Group Tour – Cranes/Doors/Platforms" briefing, 14 Apr 03
6. "Ground System Survivability Assessment/Assured Shuttle Availability (GSSA/ASA)" briefing, 14 Apr 03
7. Aerospace Safety Advisory Panel Annual Report for 2002, Mar 03
8. NASA HQ Code JX briefing, "Infrastructure Panel – Service Life Extension Program – 'Returning to Flight'," Mar 03
9. Report on the FY 02 NASA-Wide Standardized Deferred Maintenance Assessment, 10 Mar 03, NASW-02010
10. KSCARRIER PANELH-J e-mail, "Crawler Transporter Information" with attachments, 21 Mar 03
11. Analysis of FY 03 Agency-Wide Facilities Phase-Down Data (Part 3), Oct 02, Contract Number NASW-00008
12. "Welcome to the NASA Master Planning Workshop" briefing, 21 May 02
13. "Review of LC39, Pad A and Pad B Infrastructure" briefing, 10 May 02
14. Aerospace Safety Advisory Panel Annual Report for 2001, Mar 02
15. "Facilities Maintenance History, Issues & Strategy" briefing, February 02 NASA Facilities Maintenance Workshop
16. USA "Facilities Maintenance" briefing, 7 November 01
17. NASA Facilities Engineering Report, Mar 01
18. "Alternate Trajectories - Options for Competitive Sourcing of the Space Shuttle Program," Dec 02, RAND
19. "Facilities Maintenance in NASA – 2000" briefing, February 00 Facilities Maintenance Workshop
20. "Space Shuttle Program Infrastructure Revitalization to Space Flight Advisory Committee" briefing, November 00
21. Space Shuttle Program's Infrastructure Upgrade Initiative to ASAP briefing, Mar 00
22. Boeing report KLO-98-009, "Launch Pad Zinc Fallout Determination," 22 Dec 98
23. GAO report, "NASA Infrastructure – Challenges to Achieving Reductions and Efficiencies," September 96

4.0 LOGISTICS SUPPORT

4.1 WORKFORCE

Issue:

United Space Alliance (USA) has established a multi-skilled workforce to accomplish maintenance requirements on the Orbiter fleet. Observations were made of work procedures and practices.

Background:

Despite the unique requirements of such a technically advanced vehicle such as the Orbiter, the fundamental principles upon which aerospace maintenance practices and policies are based should be applicable to any such maintenance operation.

Findings:

USA technicians work at a grade structure commensurate with experience and proficiency, and are certified at skill levels. An entry-level worker starts out as "B-Tech," which, until recently, was eligible for upgrade after one year of experience. This standard has recently been changed to three years. Next experience level is "A-Tech," who can perform work alone. The senior most technician is the "AS-Tech" (Advanced System), who works closely with engineers, and are authorized to write basic work paper. These workers are limited in number, with approximately 50 among a workforce of over 4,000, typically one to two per system.

Effective tool control was observed in OPF 3 through inspection of toolboxes and discussing accountability procedures with workers. The toolboxes were professional quality, with tool locations shadowed with contoured foam, and the tools were laser etched. A common requirement was the use of tethers on ratchets to prevent Orbiter damage resulting from a dropped tool. Issue/turn-in procedures provide positive accountability with toolbox keys signed out by worker at beginning of shift, and supervisory inspection at shift's end.

The USA workforce demonstrates good teamwork, with effective interchange between technicians and engineers. Dedicated engineers are readily available to provide technicians assistance when necessary. When asked if engineering support was a problem on second shift, a tile technician worker cited that he did have to wait on occasion for assistance – "up to an hour." Time spent awaiting disposition is minimal.

Proposed Recommendations:

None.

4.2 PRODUCTION SUPPORT

Issue:

USA Integrated Logistics is effectively postured to support production with delivery of material just in time to the work site.

Background:

Over the course of three visits to KSC by team members, including tours of the NASA Shuttle Logistics Depot and production facilities such as the OPFs, observations were made of kitting practices and repair processes for components. The goal of these visits was to gain understanding of the logistics processes and organizations supporting the Space Shuttle Program.

Findings:

Much of the pre-planned jobs are supported with pre-packaged, kitted hardware delivered by the support section/tool crib. Technicians order materiel for unplanned jobs as specified by engineer disposition or drawings. Accountability for work residue (hardware left over from a job) is based on an honor system, with the worker expected to turn in unused hardware and material to Logistics. Any lost hardware left in the Orbiter is to be reported for recovery under "Lost and Found" procedures for tracking lost tools and material. USA procedures call for a formal parts and tool inventory requirement to be accomplished prior to or following work on the vehicle, with documentation on a check sheet. This policy was not observed in practice during OMM and flow at KSC.

The Logistics tool room is also being equipped with an automated tracking system to monitor benchstock issues, which will facilitate requisition of bench stock at the appropriate order point. There is a distinct possibility that leftover hardware not returned to benchstock may be retained at the worksite for future use. If not positively identified, the risk exists that the wrong hardware may be used in a future job. While two pieces of hardware may look the same, specific characteristics (material, heat treatment, hardening, and so forth) may not be readily apparent. Unaccounted hardware also poses a potential foreign object damage hazard.

The team observed a demonstration of an automated unit (resembling a sandwich vending machine) for issue and turn-in of precision tools such as torque wrenches and gages, scheduled for implementation mid-March 2003. This system interfaces with computer tracking software to monitor issue, turn-in, and calibration date, automatically flagging noncompliant tools to the user's supervisor, and preventing the issue of tools that are overdue or immediately due for calibration.

Proposed Recommendations:

NASA/USA have policies in place to control materiel being used for Orbiter maintenance that is not adequately adhered to. NASA should enforce procedures for more positive accounting of hardware, tools and materials used in end-item (such as Orbiter and External Tank) maintenance. NASA's Focus should be to minimize likelihood of items left behind in the worksite, eliminate the potential for technicians building a personal benchstock, and better facilitate the reporting of "lost-and-found" items in a timely manner. Possible options could involve the use of inventory sheets to account for quantity of hardware issued/used, rags, etc. In addition, USA should develop and implement procedures to return unused

hardware to issue point to ensure proper sorting of work residue for reutilization.

4.3 SHUTTLE SYSTEMS DEPOT SUPPORT

Issue:

USA Integrated Logistics operates an effective repair depot at the NASA Shuttle Logistics Depot (NSLD) in supporting the Space Flight Operations Contract (SFOC) to accomplish repair and overhaul of Shuttle system components.

Background:

A unique vehicle such as the Shuttle has very limited support available from the private sector. A viable alternative is to establish a robust self-supporting capability for fabrication, repair, and manufacturing of Shuttle-unique components and materials.

Findings:

The NSLD facility has eight buildings housing shops for avionics and mechanical repair, cryo testing, component/materials storage, and administrative space. The depot repairs and manufactures hardware and components for the Orbiter, and holds 250 certifications to repair 6,000 Orbiter line items, 70 percent of Orbiter line replaceable units, including analog, digital, and RF avionics, and wire harness buildup and repair. The shops also have in-house capability for thermal and vibration environmental testing. Its extensive fabrication capability is certified to manufacture 90 percent of Orbiter spares hardware. Repair capability of mechanical components includes hydraulics and structural repair such as welding, brazing, and composite/adhesive repair. The NSLD shops also have several computer numerically controlled machines capable of manufacturing a broad range of replacement fittings and mechanical devices.

USA Integrated Logistics also operates the Thermal Protection System Facility (TPSF), which manufactures Orbiter tile and thermal protective soft goods to support KSC production on a real-time basis. In addition to its manufacture capability, the TPSF accomplishes repair and fitting of TPS blankets, seals, miscellaneous protective blankets, and similar items. USA Integrated Logistics has extensive laboratory materials and processing capabilities for failure analysis of mechanical, electrical, and electronic components. Testing methodologies include spectroscopy, scanning electron microscopy, x-ray, metalography, and fractography. The Materials and Processes lab also has a broad range of inspection capabilities using a variety of technologies.

Obsolescence of test equipment will continue to pose a growing risk. NASA and Integrated Logistics are escalating their collective efforts to develop a service life extension program for all test equipment facing supportability risk due to Diminishing Manufacturing Sources (DMS).

Proposed Recommendations:

None.

4.4 BUDGETS AND FINANCIAL

Issue:

NASA planned work has been resource-constrained, leading to a cost saving emphasis in contract activities with possible bearing on program performance. Full cost accounting if implemented as intended, will better identify the cost of work and allow more flexibility in focusing resources.

Background:

Human Spaceflight Programs, including the Space Shuttle and the International Space Station, have been subject to unpredictable cost growth for a variety of reasons, including the lack of a full cost accounting system.³⁹ These budget pressures have had a profound influence on contract activities. Concern over the International Space Station (ISS) costs was a major factor in awarding the SFOC to USA.

Findings:

The Space Flight Advisory Committee (SFAC) reports from 2000 through 2002⁴⁰ indicated a general concern over extensive cost growth on the ISS while Space Shuttle costs were reflecting a decreasing trend. The cost growth was recently addressed in Congress's NASA Authorization Act of 2000 (P.L. 106-391), which provided that the Space Shuttle flights supporting the ISS must be within an overall \$17.7 billion cost limitation.

NASA is putting in place the full cost accounting⁴¹ approach as a methodology to better track current and future costs associated with the ISS and Space Shuttle programs. Basically, managers are provided with more accurate historical budget and expenditure information to support decision-making. In its simplest terms, the full cost concept ties all direct and indirect costs (including civil service personnel costs) to benefiting programs and projects. With full cost accounting, there are no "free" resources for program managers. This is in contrast to the prior approach, in which institutional

infrastructure costs, such as civil service salaries and the use of facilities and support services, were treated separately from benefiting programs and projects. See Figure 4.4.1 for a graphic representation of the NASA full cost accounting system.

NASA's annual budget history reflects considerable decline in Space Shuttle Program budgets in the recent past. In 1994 NASA, requested \$4.05 billion. This decreased to \$3.1 billion in 2002.

The Program Operating Plan (POP) is the agency-wide budget process in which NASA validates budget requirements and submissions. The POP is reviewed, consolidated, and approved at Division, Directorate, Lead Center, Program, Headquarters, Capital Investment Council, and NASA Administrator/ Comptroller levels. The POP process is iterative reflecting work and cost estimate inputs at the bottom, and high-level budget guidelines and work priorities at the top.

NASA conducts only one major POP cycle per year, but the high-risk programs, such as the ISS, may have more budget reviews. Historically, the Space Shuttle program has not been considered high risk from a budget perspective. Human space flight is contractor-driven, while many other NASA programs and projects are more closely related to civil service labor costs.

Proposed Recommendations:

The conversion to full cost accounting should be beneficial to NASA management, and provide better visibility to NASA overseers. However, the full benefit will only result if NASA, as planned, ensures program managers receive the authority to use resources identified to their programs as they see fit. This will be difficult or impossible to do without significant organizational changes and probably changes in Civil Service rules.

4.5 CONTRACTING ISSUES

Issue:

SFOC contains a complex fee formula that combines award fees, incentive fees, and performance fees. The structure of the contract award fee plan may not reward the desired performance.

Background:

NASA has historically been highly reliant on commercial sector contractors to accomplish its mission. This includes contracts with educational institutions, government labs, and the private sector, made up primarily of the aerospace-defense industry. These contracts become the vehicles in which NASA conveys its mission priorities to the commercial sector. Contract type and structure are determined on the basis of the appropriate degree of risk sharing between the government and the contractor. A wide selection of contract types is available to the government and contractors in order to provide needed flexibility in acquiring the large variety and volume of supplies and services required by NASA.

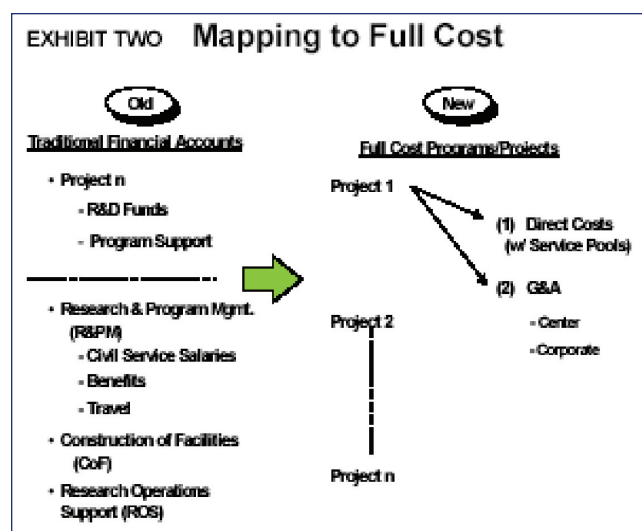

Figure 4.4.1.

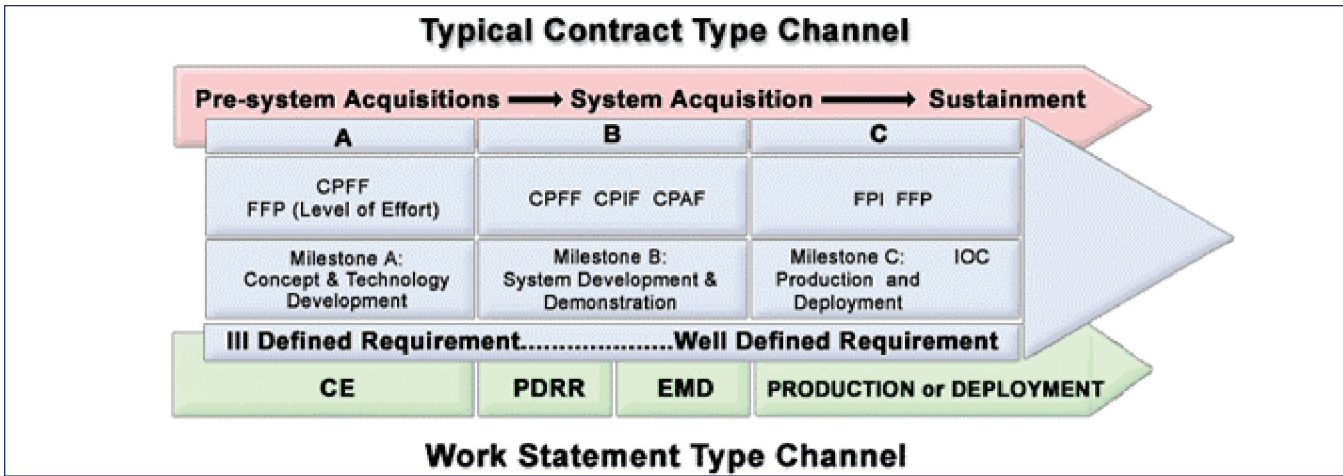

Figure 4.5.1. Typical Contract type channel.

Contract types vary according to: (1) the degree and timing of the responsibility assumed by the contractor for the costs of performance; and (2) the amount and nature of the profit incentive offered to the contractor for achieving or exceeding specified standards or goals. (See Figure 4.5.1) In general, NASA’s Space Shuttle Program element uses the cost-plus-award-fee contract format, with additional incentive fees and performance fees.

The SFOC is a combination contract containing aspects of the cost-plus-incentive-fee cost-plus-award-fee and cost-plus-performance-fee contracts. (See Figure 4.5.2) The cost-plus-incentive-fee is a cost-reimbursement contract that provides for an initially negotiated fee to be adjusted later by a formula based on the relationship of total allowable costs to total target costs.

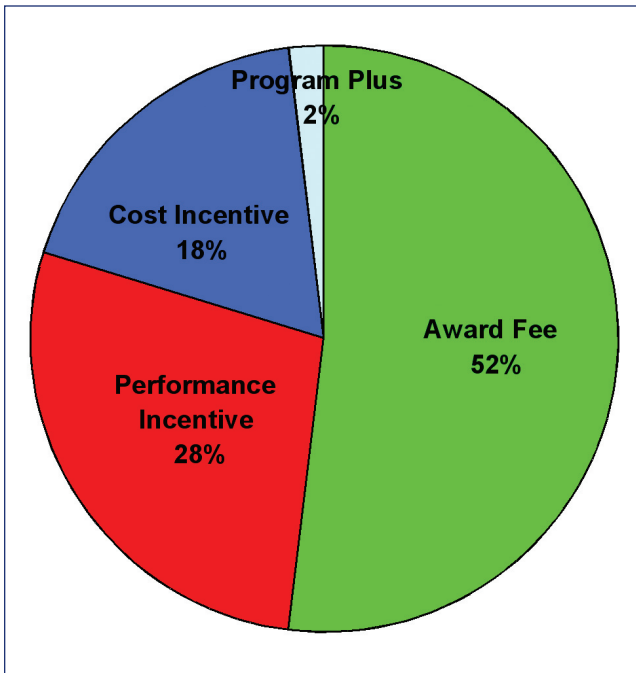

Figure 4.5.2. Available fee percentages.

A cost-plus-award-fee contract is a cost-reimbursement contract that provides for a fee consisting of a base amount fixed at inception of the contract and an award amount that the contractor may earn in whole or in part during performance and that is sufficient to provide motivation for excellence in such areas as quality, timeliness, technical ingenuity, and cost-effective management. The amount of the award fee to be paid is determined by the government’s evaluation of the contractor’s performance in terms of the criteria stated in the contract. This determination is made unilaterally by the government and is not subject to the disputes clause.

Initiatives under the Government Performance and Results Act (GPRA) encouraged agencies, including NASA, to explore better methods to accomplish agency missions through the use of commercial sector contract support. Opportunities to “contract-out” what had been historically considered inherently governmental action could potentially produce results by both decreasing contract costs and by reducing the headcount of NASA employees engaged in contract compliance.

The Kraft Report (Report of the Space Shuttle Independent Review Team) became a major impetus in moving the Shuttle Program to a contractor-managed activity. The committee made recommendations that NASA and the Space Shuttle Program should:

- (1) Establish a clear set of program goals, placing a greater emphasis on cost-efficient operations and user-friendly payload integration.
- (2) Redefine the management structure, separating development and operations and disengaging NASA from the daily operation of the Space Shuttle.
- (3) Provide the necessary environment and conditions within the program to pursue these goals.

The report further stated that, given the maturity of the vehicle, a change to a new mode of management with considerably less NASA oversight is possible at this time. In addition, the bureaucracy that has developed over the program’s lifetime – and particularly since the Challenger accident

– will be difficult to overcome and the optimum operational effectiveness of the system will be difficult to achieve unless a new management system is provided.⁴²

The Kraft review team found that NASA needed to freeze the configuration of the Shuttle and then continue to disengage from the daily operations functions of the program. The intent was to keep NASA in the development activities where the scientific expertise was most beneficial. This plan was based on the opinion that the Shuttle is a mature operational vehicle. A contract structure was to be developed that incentivized the contractor to reduce cost while maintaining safety of flight and mission success. Though NASA's narrow focus on cost reduction was criticized in the *Challenger* investigation, the committee and NASA considered much of the expense of the program to be tied up in redundant activity and excess overhead.

United Space Alliance (USA) was created by the partners, Lockheed Martin and Rockwell (Rockwell was later purchased by Boeing), to provide efficiency in managing the effort of existing Space Shuttle contractors. Prior to the formation of USA, NASA expended significant effort in the formation of a Source Evaluation Board (SEB) chartered to select a single supplier for the Space Shuttle Program. The SEB published a "sources sought synopsis" for the Space Flight Operations Contract in the Commerce Business Daily (CBD) in August 1995. This action requested that potential offerers submit statements of interest, as the prime contractor, along with specific information to support evaluation.⁴³ The Shuttle Program Director at the Johnson Space Center also presented a formal industry brief in August 1995. Four contractors (BAMSI, USA, Boeing, and McDonnell Douglas) submitted responses indicating interest. The SEB chairman recommended an award to USA based primarily on the determination that only USA had the necessary experience base and existing operational structure to minimize schedule and safety risks. The partners of the alliance already held 69 percent of the Shuttle-related contracts, which would simplify contract consolidation for NASA. After selection, NASA and the USA jointly developed incentives that would provide an appropriate reward for desired performance.

Findings:

The various fees available to USA on the SFOC could total approximately \$900 million, or approximately 10 percent of the target contract value at the negotiated target cost.⁴⁴ Award fees are the largest portions of contract fee pool. They are determined semi-annually and could total over \$500 million for the first contract period and \$165 million for the first option. The contract award fee criteria stipulate that USA must exceed the minimum "gate" score of 61 or above to earn any fee. The award fee plan criteria are broken down into ratings in seven areas. Management Effectiveness (including costs control) is the largest segment of the award fee formula at 25 percent and is closely followed by Operational Safety 20 percent, which is most heavily weighted. The remaining graded areas are Quality at 20 percent, Small Business Utilization (mandated by Agency rules) at 15 percent, Schedule at 5 percent, Manifest Effectiveness at 5 percent, Supportability at 5 percent and Cost (only level of effort

and program provisioning) at 5 percent. The structure of the SFOC Award Fee plan required a deviation from the NASA mandated attention to cost control. The NASA FAR Supplement provides that when explicit evaluation factor weightings are used, cost control shall be no less than 25 percent of the total weighted evaluation factors.^{45 46} Because of the unusual consolidation of effort included in the SFOC, the Award Fee Plan includes a provision for twelve to thirteen separate Technical Management Representatives (TMR) who rate the contractor's performance on sections of the Statement of Work, carried forward from preceding Shuttle contracts. Each TMR rates the contractor's performance, using a rating of 0-100 for all award fee ratings, other than Cost and Small Business ratings. The award fee earned is determined by applying the numerical score to the award fee pool. For example, a score of 85 yields an award fee of 85 percent of the award fee pool. No award fee shall be paid unless the total score is 61 or greater.

The NASA FAR Supplement and the SFOC contract provides the following standard adjectival ratings for the associated numerical scores:

- (1) **Excellent** (100-91): Of exceptional merit; exemplary performance in a timely, efficient, and economical manner; very minor (if any) deficiencies with no adverse effect on overall performance.
- (2) **Very good** (90-81): Very effective performance, fully responsive to contract requirements; contract requirements accomplished in a timely, efficient, and economical manner for the most part; only minor deficiencies.
- (3) **Good** (80-71): Effective performance; fully responsive to contract requirements; reportable deficiencies, but with little identifiable effect on overall performance.
- (4) **Satisfactory** (70-61): Meets or slightly exceeds minimum acceptable standards; adequate results; reportable deficiencies with identifiable, but not substantial, effects on overall performance.
- (5) **Poor/Unsatisfactory** (less than 61): Does not meet minimum acceptable standards in one or more areas; remedial action required in one or more areas; deficiencies in one or more areas, which adversely affect overall performance.⁴⁷

Weights are then assigned to the scores based upon the share of the budget. One of the most noticeable trends is that the ratings are generally very good or higher, although USA has forfeited over \$44 million in potential award fee dollars.

Overall scores for the six month periods beginning October 1996 and ending September 2002: 1) 84, Very Good; 2) 86, Very Good; 3) 81, Very Good; 4) 84, Very Good; 5) 85, Very Good; 6) 85, Very Good; 7) 83, Very Good; 8) 80, Very Good; 9) 87, Very Good; 10) 88, Very Good; 11) 88, Very Good; and 12) 91, Excellent. (See Figure 4.5.3.)

USA has earned over \$207 million in performance fees so far. USA forfeited \$1 million on STS-80 (OV-102), January 1997 (challenged by USA, resolved September 1997). This was attributed to an in-flight anomaly (IFA) that resulted

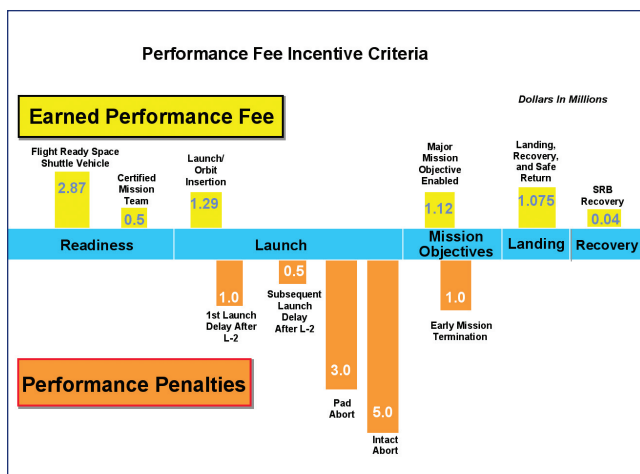

Figure 4.5.3. Amount of fee earned versus available fee.

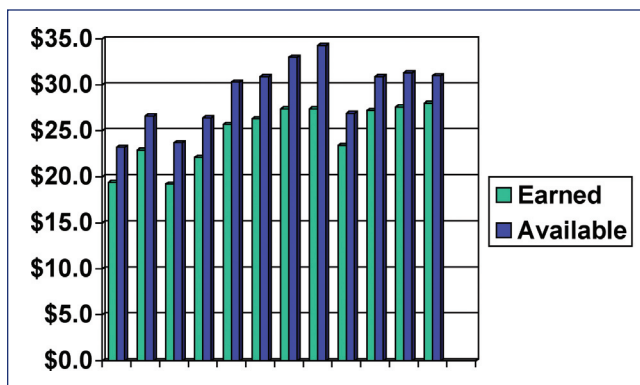

Figure 4.5.4. Performance fee incentive criteria.

in the inability to accomplish a major mission objective. Additionally, USA forfeited \$1 million on STS-92 (OV-103), September 2000, for a 24-hour launch delay and \$2.9 million on STS-103 (OV-103), January 2000, for a missed manifest launch date by more than seven days. This was attributed to workmanship damage to wiring. They forfeited \$2,87M on STS-99 (OV-105), March 2000, and \$2.9 million on STS-101 (OV-104), June 2000, both for workmanship damage to wiring. Finally, \$1.4 million was lost on STS-109 (OV-102), May 2002, due to a missed manifest date, ready for launch criteria not met.

The contract includes a unique Program Plus fee, totaling up to \$199 million, which is available at the discretion of the Program Manager. The intent of this is to provision for accomplishing or accelerating priority tasks, which were unforeseen at the start of the contract. A Cost Incentive Fee, \$178 million at target, is available to reward under-run of the estimated contract value over the entire period of the six-year contract. This has significant potential for increase if the contractor can find ways to cut the overall cost of the contract. This fee is not actually calculated until the end of the contract period when audited and negotiated costs are available. The share line allows USA to retain \$0.35 of each dollar under target cost. USA has declared an under run and has received provisional payment.

Finally, the Value Engineering Change Fee (VECP), estimated at \$4 million is to reward the contractor for recommending engineering improvements that save money. USA would get a share of any cost savings that come about because of an engineering change developed by the contractor. This is awarded on a case-by-case basis and is not aligned with a specific period.

Proposed Recommendations:

While it is extremely difficult to assign any causal relationship to the contract structure, bundling contract activities, as in the case of the SFOC, may contribute to conflicting priorities for the contractor, given the incentive to maximize the financial return associated with a contract.

4.6 SFOC AWARD FEE

Issue:

Weighting of the SFOC Award Fee may mask substandard performance in one area with higher scores in other areas.

Background:

The SFOC consolidated the work previously under 13 (originally 12) separate contracts. A formula was developed to weight award fee balloting in order to more accurately reflect the budget performance of each area. The NASA FAR Supplement discusses the weighting methodology to be used in most award fee determinations. Under this system, each evaluation factor (e.g., technical, schedule, cost control) is assigned a specific percentage weighting with the cumulative weightings of all factors totaling 100. (See Figure 4.6.1) During the award fee evaluation, each factor is scored from 0-100 according to the ratings scale. The numerical score for each factor is then multiplied by the weighting for that factor to determine the weighted score. For example, if the technical factor has a weighting of 60 percent and the numerical score for that factor is 80, the weighted technical score is 48 (80 x 60 percent). The weighted scores for each evaluation factor are then added to determine the total award fee score.

However, because the contract content of the SFOC includes divergent activities, a methodology was developed to assemble ratings of each Technical Management Representative (TMR) based on their share of the contract budget. The TMR rating is then presented to the Performance Evaluation Board, chaired by the Contracting Officer's Technical Representative (COTR). The COTR then forwards a recommendation to the Fee Determining Official (FDO). The contracting officer authorizes the payment of the Award Fee based on input from the FDO. In the case of the SFOC the delegation to the COTR includes additional delegations to the TMRs "to assist you in your delegated authorities and responsibilities."⁴⁸ Prior to the formal review process, the Johnson Space Center budget office provides the COTR with the budget share assigned to each area of the Statement of Work. These range from less than 1 percent to over 30 percent. The TMR assigns scores to the appropriate rating categories (Operational Safety and Quality, Management Effectiveness, Cost Control, Small Business, Sub-Contract Management, Manifest,

and Ground Operations). These ratings are then weighted by the assigned budget percentage. The weighted scores are then totaled to produce a total weighted score that serves as the Performance Evaluation Board recommendation.

Finding:

The effect of the weighting on the award fee process produces a series of budget drivers that become the determinants of the assigned score. The final score will be close to the score given by the TMRs rating the budget drivers (segments of the budget with a higher overall percentage of the total).

Over the course of the SFOC, there are cases when individual TMRs assigned scores of 60, which would have precluded award fee payment under the individual contracts. For example, during the eighth award fee period, April-September 2000, the TMR responsible for vehicle engineering

rated USA's performance at 60 or poor. The reason for this low score in period eight was lack of management oversight on OV-102 OMDP and missed corrosion during inspection. However, because of the weighting the overall score given to USA was higher, the composite score (and recommendation to the FDO by the board) averaged up to 79, which earned USA over \$21 million in award fees. In that case, weighting on vehicle engineering was at 22 percent, which was significant enough to reduce the score, but not below the award threshold. In another example, period nine, October 2000-March 2001, SSP Systems Integration was rated at 60 for ineffective management by SFOC over a subcontractor and cost oversight on the remotely operated fluid umbilical cited. Because it was weighted at 7.33 percent, the final score recommended to the PEB became 84, earning \$23.4 million for USA. Through the first 12 evaluation periods, there were 24 instances when the individual TMRs gave ratings below 80. However, in no cases was the final award determination by the FDO less than 80.

Proposed Recommendations:

The budget-based weighting formula, while a seemingly correct mathematical construct, may not put the proper emphasis on desired performance within each area. If each SOW area were a separate contract, the strengths and weaknesses of USA's performance would be more obvious and the TMR, COTR, and FDO would have greater leverage in rewarding above average performance. While it is recognized that the management of separate fee pools would require additional effort by the COTR and FDO, it may be appropriate to distribute the Award Fee dollars to each TMR. The dollars actually assigned to USA may end up the same in the aggregate, but high or low ratings would stand out with appropriate fee losses and gains.

TMR Weighted scoring	
• KSC Launch and	27.96
• SSP vehicle	17.67
•	14.47
• Integrated	12.03
• Solid Rocket	9.26
• SSP SYS	6.99
• Avionics andftwar	5.48
• Station Ops and	2.69
• SP	.89
• SSP	1.09
• Management	0.39
•	0.27

Figure 4.6.1. Award fee weighted scores.

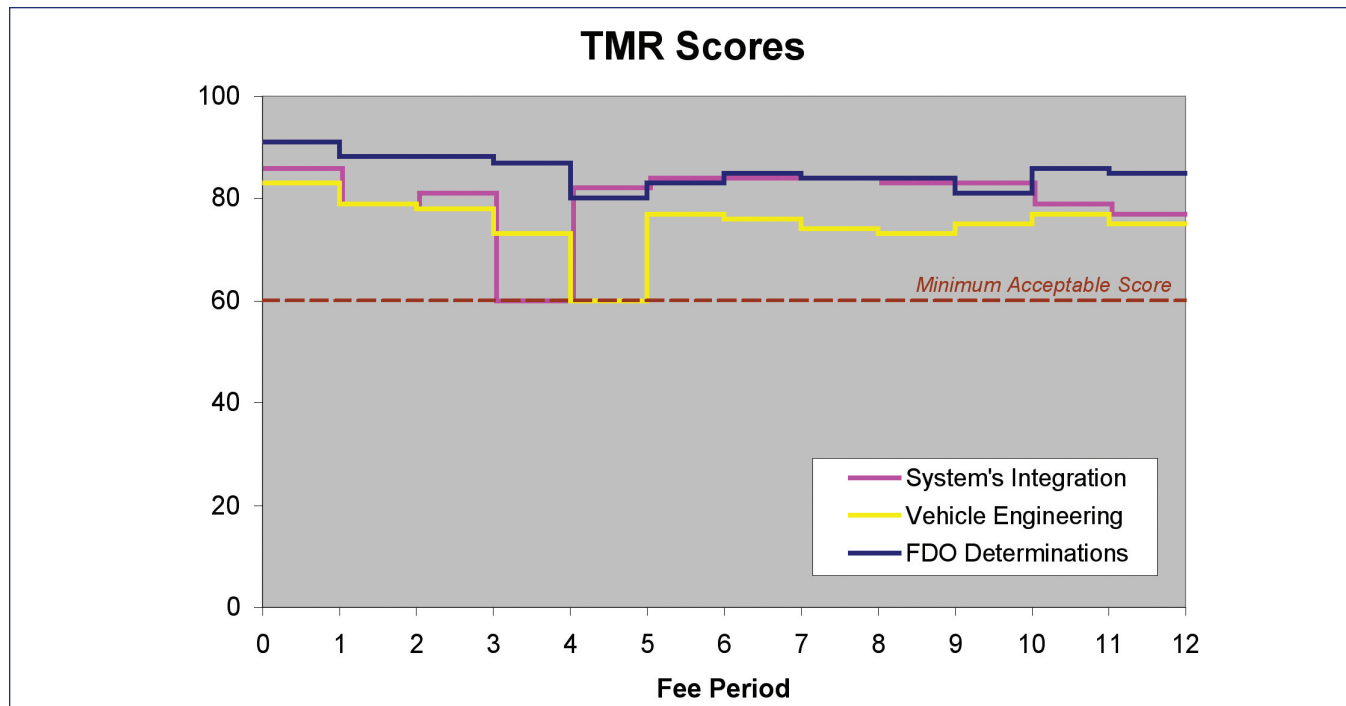

Figure 4.6.2. TMR scores.

4.7 NON-SFOC CONTRACTS

Issue:

Over time, non-SFOC contracts have “evolved” to shift emphasis away from cost savings.

Background:

Marshall Space Flight Center (MSFC) has contract cognizance over Space Shuttle Program element contracts that are not within the SFOC. These include the Space Shuttle Main Engine (SSME), External Tank (ET), and the Reusable Solid Rocket Motor (RSRM). MSFC also had contract cognizance over the Solid Rocket Booster, until 1998. That element has since been transitioned to USA, originally as a directed subcontract to USBI. All other element contracts were “on the table” to be included in the SFOC as part of future phases, but those decisions have not yet been implemented.

Findings:

Boeing Rocketdyne manufactures the SSME. Rocketdyne has been the supplier since 1972,⁴⁹ when it was awarded the SSME development. The current contract, awarded in 2002 is for \$1.2 billion and requires the effort necessary to meet six flights per year, with continued availability of 12 flight ready engines.⁵⁰ The contract includes incentives of over 11 percent – 5 percent for award fee and 5.5 percent in performance fees. (See Figure 4.7.1.)

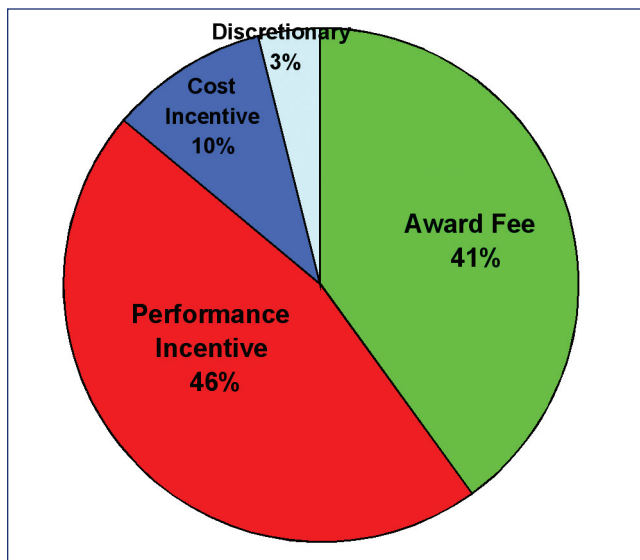

Figure 4.7.1.

Award fees are based on the following evaluation criteria: Management 30 percent; Flight Support 40-60 percent; Safety and Mission Assurance less than 30 percent. The weights of each criterion are determined at the beginning of each fee period and are conveyed to the contractor. As with other Space Shuttle contracts, the award fee is determined in six month periods, with the Performance Evaluation Board (PEB) recommending the score to the Fee Determining Offi-

cial. The PEB at Marshall is comprised of the center’s senior management, intended to provide an independent review of the COTR evaluation.⁵¹ (See Figure 4.7.2)

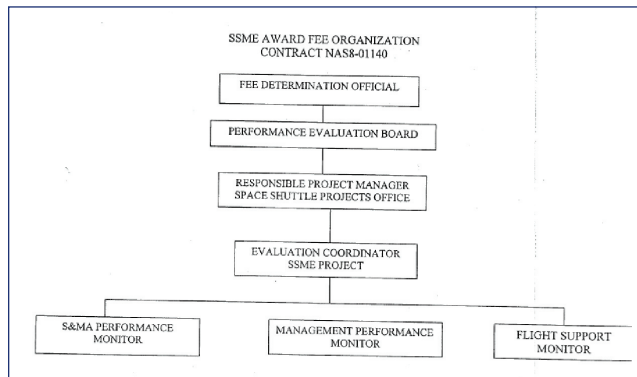

Figure 4.7.2 Performance Evaluation Board.

The SSME contract does not permit “rollover” of any unearned fee. Rollover provisions place unearned award fee funds into a virtual suspense account that could be earned by the contractor in the future for tasks not identified in the original fee plan. The award fee also serves as a cost incentive “gate” in that the incentives earned for cost reduction will not be paid unless the award fee score average is above 70. Additionally, for score averages below 85, there are caps applied to overrun earnings. During the current contract period, Boeing has earned fees of over \$8.6 million with scores of 81.2 and 91.4. (See Figures 4.7.3 and 4.7.4)

The SSME contract places more potential fee dollars, and

Evaluation Period	Start Date	End Date	Avail. Award Fee Dollars	Dollars Earned	Dollars Not Earned	Overall Score
1	1/1/02	6/30/02	\$4,823,679	\$3,916,827	\$906,852	81.20%
2	7/1/02	12/31/02	\$5,222,203	\$4,773,094	\$449,109	91.40%
3	1/1/03	6/30/03	\$5,370,488			
4	7/1/03	12/31/03	\$5,261,730			
5	1/1/04	6/30/04	\$5,111,443			
6	7/1/04	12/31/04	\$5,051,295			
7	1/1/05	6/30/05	\$5,118,927			
8	7/1/05	12/31/05	\$4,950,116			
9	1/1/06	6/30/06	\$5,182,323			
10	7/1/06	12/31/06	\$4,906,367			
			\$50,998,571			

Figure 4.7.3. SSME Fees Earned.

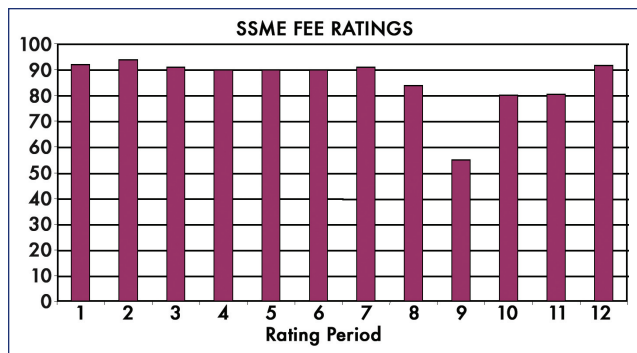

Figure 4.7.4. Boeing’s ratings for the previous contract.

therefore more contract emphasis, on the performance success of the SSME. Each engine delivered on-time earned \$1.5 million plus an additional \$1.2 million paid for each successful launch.

MSFC has placed a more balanced emphasis on cost control on the External Tank procurement in contrast to the performance emphasis on the SSME contract. (See Figure 4.7.5) The ET contract was awarded to Martin Marietta (now Lockheed Martin) in 1973 for production of the first seven tanks.⁵² The current contract, awarded in 1999, calls for the delivery of 35 tanks and 60 ship sets of flight hardware. The

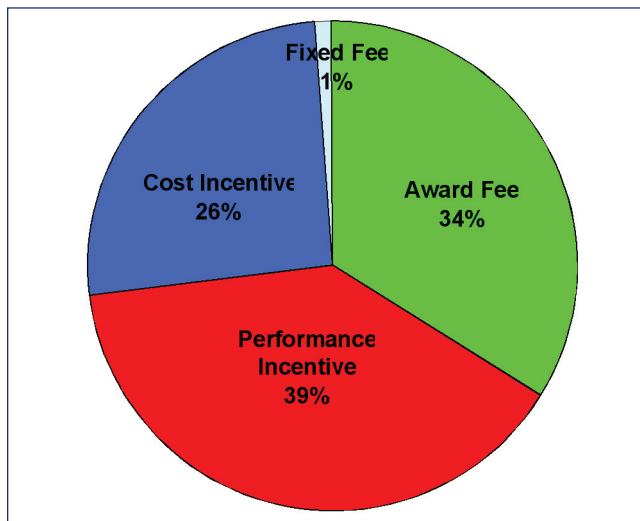

Figure 4.7.5. External Tank Contract Fee Distribution.

additional flight hardware is then used for the production of the next ET order. The contract also provides for the operation and maintenance of the Michoud Assembly Facility (MAF). Within this single contract, MFSC has included four separate fee plans, each with differing emphasis. The cost incentive is greatest on the long lead procurement portion and least on the friction stir weld upgrade (a product technology improvement). The award fee weights assigned are different for the contract portions as well. Production quality on the ET is weighted at 70 percent and management performance is weighted at 30 percent. In MAF operations, operations and maintenance is weighted at 20-30 percent, production support at 20percent, construction of facilities at 30 percent, and environmental compliance at 30-40 percent. The history of Lockheed Martin's earnings of fees is displayed on Figure 4.7.6.

The ET contract also include performance incentives fee of 3.8 percent. This is distributed to safety (accidents/incidents), 1.14 percent; on-time delivery, 1.14 percent; launch success, 0.38 percent; and flight success, 1.14 percent. The dollar amount of these incentives are: delivery of approximately \$347 thousand; launch success of approximately \$115 thousand and flight success of \$233 thousand. The safety incentive is based on hours worked over an annual period. One unique aspect of the ET performance award is that the flight success awards are granted after the Tank remains unused for twelve months. This is because NASA accepts the ET at the Michoud facility and the tank may remain unused for long periods, awaiting the flight schedule. Lockheed Martin also has included an employee motivation award that rewards each employee based on the contractor's earned fees. As the only major non-reusable Shuttle element, the design of the

Production Award Fee Pools				
Period	Amount Available		Earned Amount	Earned Percent
October 1, 2000 - March 31, 2001	\$1,499,664		\$1,370,693	91.40%
April 1, 2001 - September 30, 2001	\$2,493,361		\$2,202,136	88.32%
October 1, 2001 - March 31, 2002	\$3,273,186		\$3,070,903	93.82%
April 1, 2002 - September 30, 2002	\$2,498,684		\$2,296,290	91.90%
Total	\$9,764,895		\$8,940,022	91.55%

MAF Operations & Maintenance Award Fee Pools				
Period	Amount Available		Earned Amount	Earned Percent
October 1, 2000 - March 31, 2001	\$345,327		\$334,622	96.90%
April 1, 2001 - September 30, 2001	\$485,448		\$461,661	95.10%
October 1, 2001 - March 31, 2002	\$658,718		\$645,544	98.00%
April 1, 2002 - September 30, 2002	\$761,736		\$717,555	94.20%
Total	\$2,251,229		\$2,159,382	95.92%

B02063 – "Implementation of Friction Stir Welding" Award Fee Pools				
Period	Amount Available		Earned Amount	Earned Percent
May 1, 2000 - March 31, 2001	\$ 343,218-		\$314,044	91.50%
April 1, 2001 - September 30, 2001	\$297,000		\$268,785	90.50%
October 1, 2001 - March 31, 2002	\$128,000		\$114,278	89.28%
April 1, 2002 - September 30, 2002	\$84,687		\$83,840	99.00%
Total	\$852,905		\$780,947	91.56%

Figure 4.7.6. Lockheed Martin Michoud Fees Earned.

Tank has been relatively stable. The ET contract has been considered for a fixed price contract transferring much of the financial risk of accomplishment to the contractor. The ET was being considered for a competition in the next award.⁵³

The NASA contract system was criticized in an October 29, 1986, report by the House Committee on Science and Technology that stated: “Existing contract incentives do not adequately address or promote safety and quality concerns. Most emphasis is placed on meeting cost and schedule requirements.”⁵⁴ Today, Marshall places much less emphasis on cost savings, than cost control, as budget management is a significant award fee criterion.⁵⁵

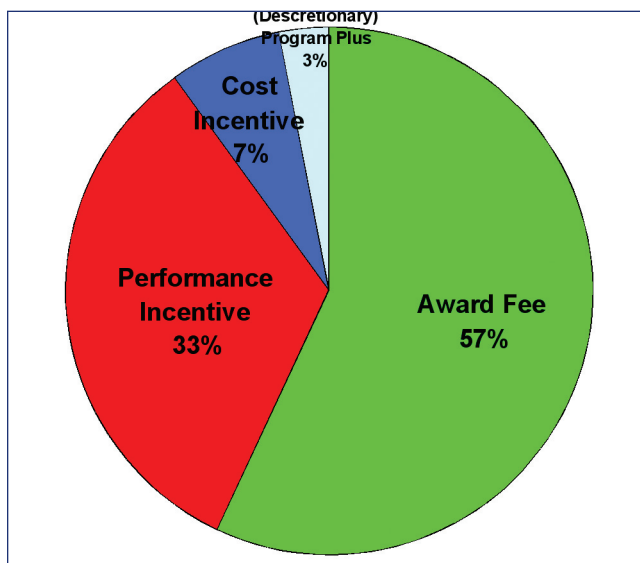

Figure 4.7.7. Reusable Solid Rocket Motor Fee Distributions.

The RSRM is the only major element contract that includes no incentive for cost under-run. While there is a one percent incentive in the contract to meet the target cost, the fee does not increase for cost under-run. (See Figure 4.6 7) Discussions with the Program offices revealed that it was a conscious decision not to add incentives for further cost reductions by the contractor. Concern was raised that the headcount had been reduced to the lowest level while maintaining safe operations and that further reductions would increase the risk to the program.

The award fee can total up to a potential fee of 8.5 percent. The fee plan is weighted 50 percent for performance management and 50percent for safety and mission assurance. The contract was changed in Buy 4 to eliminate the provision for rollover of unearned award fee (see above). On the previous RSRM contracts (Buy 3), there was a reallocation of the unearned award fees through the rollover provision.⁵⁶ The performance incentive portions of the fee structure amount to a potential 5percent of the available fee. These fees are earned for; on-time delivery - 2percent or approximately \$1.2 million; per ship set assembly - 0.5 percent or approximately \$300 thousand; launch/flight performance – 2.5 percent or approximately \$1.5 million flight. (See Figure 4.6.8 for RSRM history)

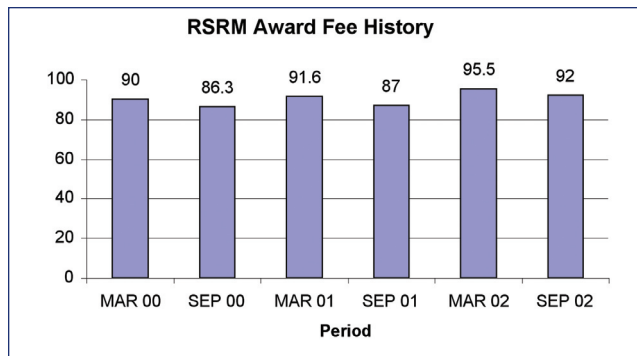

Figure 4.7.8. RSRM fee history.

In summary, the various treatments of fees on the Marshall managed program illustrate that the government can use several techniques to convey program emphasis through contract incentives. In the case of the External Tank, multiple incentive fee plans are used to appropriately reward different types of effort on the same contract. In the case of the SSME, the contract reflects that the element is still considered high risk and performance success is paramount. Finally, in the case of the RSRM, the government recognizes that while cost control is important, continued cutting of program costs may increase risk and therefore should not be rewarded.

Proposed Recommendations:

MSFC has demonstrated that the contract can be used to recognize the evolved state of the contractual performance while recognizing that the SFOC statement of work differs greatly in the contracts for the ET, SSME, and RSRM. NASA should consider subdividing the SFOC, to reflect differing emphasis on cost savings or performance, rather than the averaging of performance now present in the contract. When and if the element contracts are bundled into the SFOC, NASA should consider the history at MSFC and maintain the best practices in terms of contract incentives.

4.8 CONTRACTUALLY REQUIRED DOCUMENTS APPLICABLE TO EXTERNAL TANK THERMAL PROTECTION SYSTEM (TPS) FOAM APPLICATION

Issue:

Foam application process is not specified as a contractual requirement.

Background / Facts:

Marshall Space Flight Center contract number NAS8-00016 covers the period from September 27, 1999 through December 1, 2008 for the production of External Tanks numbered ET-121 through ET-156. Contract number NAS8-36200 includes the effort for the production of external tanks 61-120.⁵⁷ Lockheed Martin’s manufacturing and process plans (MPP) specify the application processes currently in use at the MAF for the external tank production. The statement of

work (SOW) (Figure 4.8.1) included in the contracts contains the Index of Compliance Specification, Documents and Deviations. This index lists the Type 1 documents applicable to the contract. Document Number MMC-ET-CM02a provides the Prime Equipment Detail Specification. CMO2 identifies all the technical requirements that are pertinent to the ET. This document contains a cross-referenced matrix to identify the NSTS 07700 Volume X, which specifies Space Shuttle Program requirements. The ET Project Manager and Contracting Office must approve all changes to CM02 (as is a Type 1 document) prior to implementation. A Preliminary Specification Change Notice (PSCN) is drafted and submitted to NASA as part of a Change Summary. This requirement further flows to MMC-ET-SE16, the Materials and Processes Control Plan that specifies the materials and the processes for the ET including the thermal protection system (TPS). Since this is also a Type 1 document, all changes must be processed through the NASA ET project office as well. A preliminary drawing change notice (PALMDALECN) is drafted as part of a change summary. However, at a specification level below SE16, NASA initially approves Engineering Material Specifications (STM) and Engineering Process Specifications (STP), and coordinates changes.

Manufacturing Process Plans (MPP) provides the fabrication instructions. They may include processes describing all manufacturing operations, operational buy offs and data recording, or may provide general instruction referencing specific processes with limited data recording and minimal buy off. Buy offs include production, production assurance, or government inspection agency (GIA) and may include inspections of critical items list (CIL) items. The MPPs are under the control of Lockheed Martin. Changes to the MPPs are not required to be coordinated with the government unless they affect form, fit, or function. NASA and DCMA are to review any contractor implemented changes that affect form, fit, or function.

Proposed Recommendations:

None.

4.9 CONTRACTUAL PENALTIES FOR EXTERNAL TANK FAILURE

Action:

The external tank used on STS-107 was not subject to a catastrophic loss penalty clause.

Background / Facts:

After the *Challenger* accident, NASA contracting officers began to include catastrophic loss clauses in the Space Shuttle Program ET contract.⁵⁸ The last Marshall Space Flight Center ET contract included the production of External Tank 93, which was delivered in 2000 and used on STS-107. The government accepted delivery of this tank and held it until needed. The catastrophic failure clause (included in the current contract, section B5) provides that Lockheed Martin is assessed a fee reduction in the event of any critical category I or category II failures on a Space

Shuttle mission using ET-121 through ET-156. A category I failure is an incident directly caused by external tank hardware that results in death of a Shuttle crewmember or “total loss of the Shuttle Orbiter Vehicle.”⁵⁹ A category II failure is an incident directly caused by external tank hardware that results in a mission failure. The fee reduction for a category I failure is \$5 million or \$10 million for a category II failure. The category II or I failure determination will be made by a Failure Investigation Board (convened and conducted in accordance with the requirements of NASA Management Instruction NMI 8621.1).

Similar contract clauses are include in the Space Shuttle Operations Contract (SFOC) and contracts for the Space Shuttle Main Engine (SSME) and Reusable Solid Rocket Motor (RSRM). Some contracts include forfeiture of any fees earned during the period in which a catastrophic loss occurs. However, the ET used on STS-107 was delivered under the previous contract, NAS8-36200. Lockheed Martin had requested, in negotiation discussions incident to that contract, that the available fees be raised considerably if NASA were to request inclusion of a catastrophic loss clause.⁶⁰ The Marshall negotiators considered the potential increase in the contract price and determined that the benefits of the clause did not justify the cost.

Findings:

The absence of a specific catastrophic loss clause does not necessarily mean that the contractor is exempt from financial penalties, should responsibility be determined.

Proposed Recommendations:

Should the Board determine that the External Tank was a causal factor to the accident and further determine that the contractor is culpable, complete contract review should be accomplished to identify whether other provisions exist in prior contracts to assign penalties or fee forfeitures

4.10 WORKFORCE: SIZE AND AGING

Action/Issue:

The NASA/contractor workforce is aging and may not be adequate to do its assigned mission.

Background:

Since NASA was established in 1958, its civil service workforce has fluctuated widely. In 1967, at the height of the Apollo program, the workforce reached approximately 35,900 personnel. In the mid-70s an involuntary separation program decreased the workforce by several thousand employees. By 1980, the workforce had stabilized near 21,000. It remained close to that level until 1986, when the Space Shuttle *Challenger* accident forced a reexamination of NASA, adding significant man-hours to Safety and Quality Assurance processes.

NASA began some ambitious new programs in the late 1980s and its workforce began to grow again peaking in

1992 at more than 25,000. When the Clinton administration took office in 1993, it initiated steps to reduce the size of the overall federal workforce. Total NASA headcount went from approximately 25,000 civil servants in FY1993 to slightly more than 18,000 (full-time permanents) by the end of 2002. As the NASA workforce declined, the continuing strategy was to lose junior personnel first, resulting in an experienced but aging workforce. In November 1995, NASA selected United Space Alliance – a Rockwell International and Lockheed Martin partnership – as the prime contractor for space flight operations. Thus, fewer civil servants were required to manage the program. NASA estimated that it would be able to make personnel reductions in the range of 700 to 1,100 full-time equivalent personnel (FTE) at the Kennedy Space Center alone. The challenge to Space Shuttle contractors, including United Space Alliance, was to address the aging workforce concerns through a continual influx of inexperienced personnel who could stay with the industry for many years. Contractors have much more flexibility in their personnel decisions than does the federal government. Compensation packages, including both wages and benefits, are tailor made to address the shortages that face the industry while correcting oversupply in some skills. All SSP contractors, including United Space Alliance, have been given financial incentives to reduce the cost of performing the contract. Personnel costs can be reduced by eliminating personnel in overhead support or management functions, or by encouraging efficiencies in the direct labor elements. United Space Alliance, through the Space Flight Operations Contract, is accountable for professional, managerial, and technical workforce support to the Space Shuttle Program. Jobs range from maintenance personnel at Kennedy Space Center to subsystem managers within the Mission Control structure. USA recognized its obligation to maintain a balanced workforce in professional skills, and that there must be a flow of personnel through the “pipeline” to guard against future shortfalls in critical skills.

United Space Alliance stated that while they accepted the challenge to reduce the headcount on the Space Shuttle Program, they intended to do so without reducing the direct headcount. They would do this primarily through efficiencies achieved by consolidations. USA did not place the same emphasis on the retention of the non-professional, technician workforce. USA has stated that it does not suffer from the same concerns as with engineers and has never faced a shortage of applicants for these jobs.

United Space Alliance closely tracks personnel trends, especially with respect to engineering manpower. USA has a nearly bimodal distribution with respect to age or experience. There are a significant number of personnel over 40 years of age as well as a significant number in the under-30 age group. This illustrates a pipeline from which the workforce of the future will be drawn. Other Space Shuttle contractors may not have had the flexibility to make these kinds of “overhead only” process gains, as elimination of direct as well as indirect personnel was necessary. While reducing the cost of labor through lay-offs, the contractor must continually guard against creating an impression of the company as an unattractive workplace. Contrast the United Space Alliance distribution with ATK Thiokol Propulsion in Utah, the

supplier of the Reusable Solid Rocket Motor (RSRM) since the 1970s.

During the peak production of the RSRM in the 1980s Thiokol employed over 4,000 personnel. Today, with production of the RSRM at less than 30 units annually, their personnel count is stable at 1,350. Demographics at the Utah plant show a spike in the 45-49 age group, with the majority of the workforce being over 45 years old. This trend is true for engineering as well as plant personnel. ATK Thiokol has identified their aging workforce as a significant issue in relation to the Service Life Extension Program (SLEP). ATK Thiokol recognizes that they must “pump significant new energy into recruiting new talent and retaining/training the younger ones currently in our workforce now.”⁶¹ The contracting community at Marshall Space Flight Center recognized the risk associated with downsizing and has eliminated incentives associated with cost cutting in the latest RSRM contract.

The Michoud Assembly Facility workforce has been declining over the past five years. In 1998, there was some increase in hiring as a result of the RLV and X-33 programs. However, after that, hiring was limited to budget-driven replacements only. Budget challenges have led to involuntary separations, which approached 10 percent in 2002. One of the risks of multiple periods of downsizing is that it may lead to a perception among the workforce of limited potential for both growth and reliable employment. This has been highlighted as one of the most significant reasons for the voluntary attrition over the past three years. The average age of the employee at Michoud is now 47.8 years, but the skilled labor (represented) employees average 48.2 years.

In conclusion, the issues associated with aging workforce present formidable challenges to the future of the Shuttle Program, especially if the vehicle is expected to serve until 2020 and beyond. Of the major contractors, only USA has a recruiting effort with significant numbers.

Additionally, while USA’s benefit packages have been considered by some to be below the industry standard, we have reviewed DCAA documentation that reflects that the packages are among the best in the industry and may actually be considered excessive.

Proposed Recommendation:

It is essential that NASA take actions to ensure a stable experienced base of support for the Shuttle programs. This may require modifications to the way contract incentives are used or other contractual arrangements or changes. It may benefit NASA to continue the bundling of Space Shuttle element contracts, ET, SSME, and RSRM under the SFOC and USA in order to maximize the return on leverage of personnel recruitment efforts.

ENDNOTES

- ¹ Boeing Inspection Report, OV-102, Wire Inspection Report, September 1999-February 2001.
- ² Boeing Inspection Report, OV-102 J3 V30/V31, September 1999-February 2001, p. 13.
- ³ Boeing briefing, "Arc Tracking Separation of Critical Wiring Redundancy Violations," present to NASA April 18, 2001, Joe Daileida, Bill Crawford.
- ⁴ Minutes of Orbiter Structures Telecon meeting, June 19, 2001, held with NASA, KSC, USA, JSC, BNA-Downey, Huntington Beach, and Palmdale Shuttle Operations Assessment Group (SOAG), Safety Reporting Database-SOAG 99-069, Aug. 25, 1999, Engineering Support Request ESR K16460
- ⁶ SRB Forward Separation Bolt Test Plan, Doc Number 90ENG-00XX, 2 Apr 2003
- ⁷ Contract F08650-00-C-0005: CSR Technical Report -Debris, Analysis Report For Operation F1120, Shuttle STS-107, 16 January 2003, Revision 1 (Cdr A205), pg 29
- ⁸ Contract F08650-00-C-0005: CSR Technical Note -Bolt Catcher Debris Analysis For Shuttle STS-107 (CDR A205), 25 June 2003, pg 29
- ⁹ Marshal SFC briefing on Bolt Catcher Test Plan, Joe Gentry, 5 April 2003
- ¹⁰ "Non-Destructive Test Evaluation Assessment of Pacific Magnetic & Penetrant Inc., Bellringer #03-0-W/14, March 2003, DCMA Phoenix, DCMA-GPOZD.
- ¹¹ Aerospace Safety Advisory Panel, Annual report for 2002, 32.
- ¹² Space Shuttle Processing Independent Assessment Report for USA, April 23, 2001, 30.
- ¹³ USA Operating Procedure: Hardware Photographic Documentation. No. USA 004663, 11/27/02, p 1.
- ¹⁴ CAIB request for information #B1-001178
- ¹⁵ Space Shuttle Independent Assessment Report for United Space Alliance, April 23, 2001, page 46.
- ¹⁶ Space Shuttle Processing Independent Assessment Report for USA, April 23, 2001, pg 22.
- ¹⁷ Report of the Presidential Commission on the Space Shuttle Challenger Accident (In compliance with Executive Order 12546 of February 3, 1986)
- ¹⁸ Space Shuttle Independent Assessment Team, Report to Associate Administrator, October-December 1999, March 7, 2000, pg 51
- ¹⁹ Ibid.
- ²⁰ Various informal testimony gathered by Board members and staff while traveling to NASA sites.
- ²¹ Space Shuttle Independent Assessment Team, Report to Associate Administrator, October-December 1999, March 7, 2000, pg 53
- ²² Standard Operating Procedure, Foreign Object Debris (FOD) Reporting, Revision A, Document Number: SOP-O-0801-035, October 01, 2002, United Space Alliance, KSC, 3.
- ²³ Ibid, pg 2.
- ²⁴ National Aerospace FOD Prevention, Inc., Rev E July 2000, 1.
- ²⁵ Ibid.
- ²⁶ SFOC, Performance Measurement System Reports for January 2003, February 25, 2003, USA004840, issue 014, contract NAS9-20000.
- ²⁷ Space Shuttle Processing Independent Assessment Report for USA, April 23, 2001, 22.
- ²⁸ Kennedy Space Center Processing Review Team Assurance Engineering Final Report, April 2003: Safety, Quality, Industrial Engineering, Corrective Action Human Factors, and Reliability
- ²⁹ STS-107 and STS-109 Engineering Process Review Team (PRT) Systemic Analysis (Assurance Engineering Review), May 23, 2003
- ³⁰ KSC Processing Review Team Final Summary, USA, June 10, 2003
- ³¹ KSC Processing Review Team Final Summary, USA, June 10, 2003
- ³² NASA brief, "CAIB Informal Action: Orbiter Life Extension- History/ Current Status," 6/02/03.
- ³³ Ibid.
- ³⁴ Followup Audit on Orbiter Maintenance Down Periods at KSC, June 12, 1998, NASA Office of the Inspector General, pg 2 et al.
- ³⁵ NASA Briefing, presented 7 May, 2003, by the SLEP program manager during a SLEP video telecom.
- ³⁶ NASA briefing, presented 7 May, 2003, by the SLEP program manager during a SLEP video telecom.
- ³⁷ NASA briefing, presented 7 May, 2003, by the SLEP program manager during a SLEP video telecom.
- ³⁸ NASA Langley Briefing to the CAIB, Presented 12 May 2003, by Mark J. Shuart, et al.
- ³⁹ Statement of Russell A. Rau, Assistant Inspector General for Auditing National Aeronautics and Space Administration before the House Committee on Science, April 4, 2001
- ⁴⁰ Minutes of the Space Flight Advisory Committee, May 3, 2002, 1.
- ⁴¹ Full Cost Management: Background, Purpose, Legislative Proposals, January 1998.
- ⁴² Report of the Space Shuttle Management Independent Review Team, February 1995, Dr. Christopher Kraft, pg 12.
- ⁴³ Statement of Daniel Goldin to the Subcommittee on Space and Aeronautics Committee on Science U.S. House of Representatives, November 30, 1995.
- ⁴⁴ SFOC Briefing and discussion with the CAIB, March 17, 2003.
- ⁴⁵ SFOC Post Negotiation memorandum, September 23, 1996
- ⁴⁶ NASA FAR Supplement 1816.405-274
- ⁴⁷ NASA FAR Supplement 1816.405-275
- ⁴⁸ The Contracting Officer Technical Delegation, July 18, 2001, form 1634.
- ⁴⁹ SSME CAIB Briefing and discussion April 30, 2003
- ⁵⁰ Contract Number NAS8-01140
- ⁵¹ Award Fee Plan for Contract Number NAS8-01140
- ⁵² CAIB External Tank Contact Briefing, April 30, 2003
- ⁵³ ET Program Discussions, April 30, 2003
- ⁵⁴ Thiokol got 'flight success' bonus a week before disaster, Houston Chronicle, November 20, 1986
- ⁵⁵ Ibid.
- ⁵⁶ CAIB ET Contract Briefing, April 30, 2003
- ⁵⁷ NASA External Tank Contract Briefing to the CAIB, April 30, 2003
- ⁵⁸ "NASA ponders \$10 Million Thiokol Fine," Houston Chronicle, November 19, 1986
- ⁵⁹ NASA contract with Lockheed Martin for ET production, NAS8-00016.
- ⁶⁰ CAIB discussion with ET contracting and program office, April 30, 2003.

THIS PAGE INTENTIONALLY LEFT BLANK